

15:1 Fire-Ball[®] Stationary or Mobile Fluid Dispense Packages

307882G

EN

For dispensing non-corrosive or non-abrasive lubricants in stationary or mobile installations. For professional use only.

Not approved for use in European explosive atmosphere locations.

2750 psi (18.9 MPa, 189 bar) Maximum Working Pressure

Model 222078, 241043* - 35 pound pails size

Model 220170, 241044* - 120 pound drum size

Model 220171, 241045* - 400 pound drum size

**CE Approved Models*

Technical Data, included wetted parts for Fire-Ball Pumps used in these packages is provided in pump manual 306531.

Models:
220171, 241045

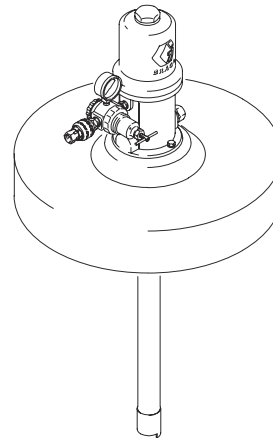

Models:
220170, 241044

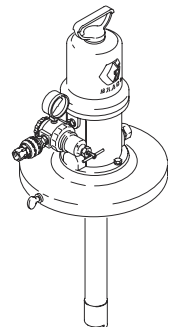
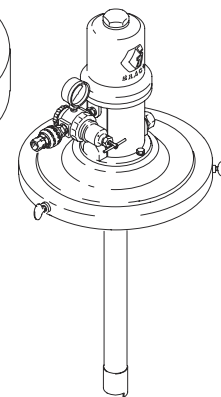

Models:
222078, 241043











Important Safety Instructions

Read all warnings and instructions in this manual and the Fire-Ball Pump Manual. Save these instructions.





Warnings

The following warnings are for the setup, use, grounding, maintenance, and repair of this equipment. The exclamation point symbol alerts you to a general warning and the hazard symbols refer to procedure-specific risks. When these symbols appear in the body of this manual, refer back to these Warnings. Product-specific hazard symbols and warnings not covered in this section may appear throughout the body of this manual where applicable.

 <h2 style="margin: 0;">WARNING</h2>	
 	<p>EQUIPMENT MISUSE HAZARD</p> <p>Misuse can cause death or serious injury.</p> <ul style="list-style-type: none"> • Do not operate the unit when fatigued or under the influence of drugs or alcohol. • Do not exceed the maximum working pressure or temperature rating of the lowest rated system component. See Technical Data in all equipment manuals. • Use fluids and solvents that are compatible with equipment wetted parts. See Technical Data in all equipment manuals. Read fluid and solvent manufacturer's warnings. For complete information about your material, request MSDS from distributor or retailer. • Do not leave the work area while equipment is energized or under pressure. Turn off all equipment and follow the Pressure Relief Procedure when equipment is not in use. • Check equipment daily. Repair or replace worn or damaged parts immediately with genuine manufacturer's replacement parts only. • Do not alter or modify equipment. • Use equipment only for its intended purpose. Call your distributor for information. • Route hoses and cables away from traffic areas, sharp edges, moving parts, and hot surfaces. • Do not kink or over bend hoses or use hoses to pull equipment. • Keep children and animals away from work area. • Comply with all applicable safety regulations.
  	<p>SKIN INJECTION HAZARD</p> <p>High-pressure fluid from dispensing device, hose leaks, or ruptured components will pierce skin. This may look like just a cut, but it is a serious injury that can result in amputation. Get immediate surgical treatment.</p> <ul style="list-style-type: none"> • Do not point dispensing device at anyone or at any part of the body. • Do not put your hand over the fluid outlet. • Do not stop or deflect leaks with your hand, body, glove, or rag. • Follow the Pressure Relief Procedure when you stop dispensing and before cleaning, checking, or servicing equipment. • Tighten all fluid connections before operating the equipment. • Check hoses and couplings daily. Replace worn or damaged parts immediately.
 	<p>MOVING PARTS HAZARD</p> <p>Moving parts can pinch, cut or amputate fingers and other body parts.</p> <ul style="list-style-type: none"> • Keep clear of moving parts. • Do not operate equipment with protective guards or covers removed. • Pressurized equipment can start without warning. Before checking, moving, or servicing equipment, follow the Pressure Relief Procedure and disconnect all power sources.



WARNING





 	<p>FIRE AND EXPLOSION HAZARD</p> <p>When flammable fluids are present in the work area, such as gasoline and windshield wiper fluid, be aware that flammable fumes can ignite or explode. To help prevent fire and explosion:</p> <ul style="list-style-type: none"> • Use equipment only in well ventilated area. • Eliminate all ignition sources, such as cigarettes and portable electric lamps. • Keep work area free of debris, including rags and spilled or open containers of solvent and gasoline. • Do not plug or unplug power cords or turn lights on or off when flammable fumes are present. • Ground all equipment in the work area. • Use only grounded hoses. • If there is static sparking or you feel a shock, stop operation immediately. Do not use equipment until you identify and correct the problem. • Keep a working fire extinguisher in the work area.
	<p>TOXIC FLUID OR FUMES HAZARD</p> <p>Toxic fluids or fumes can cause serious injury or death if splashed in the eyes or on skin, inhaled, or swallowed.</p> <ul style="list-style-type: none"> • Read MSDSs to know the specific hazards of the fluids you are using. • Store hazardous fluid in approved containers, and dispose of it according to applicable guidelines.
	<p>PERSONAL PROTECTIVE EQUIPMENT</p> <p>You must wear appropriate protective equipment when operating, servicing, or when in the operating area of the equipment to help protect you from serious injury, including eye injury, hearing loss, inhalation of toxic fumes, and burns. This equipment includes but is not limited to:</p> <ul style="list-style-type: none"> • Protective eyewear, and hearing protection. • Respirators, protective clothing, and gloves as recommended by the fluid and solvent manufacturer.

Installation

- Reference number and letters in parentheses in the text refer to call outs in the figures and drawings.
- Always use genuine Graco Parts and Accessories, available from your Graco distributor.

To maintain grounding continuity when flushing or relieving pressure: hold metal part of the dispense valve firmly to the side of a grounded metal pail, then trigger the dispense valve.

Grounding

						
The equipment must be grounded. Grounding reduces the risk of static and electric shock by providing an escape wire for the electrical current due to static build up or in the event of a short circuit.						

Pump: use ground wire and clamp as shown in FIG. 1. Remove the ground screw (Z) and insert through the eye of the ring terminal at the end of the ground wire (Y). Fasten the ground screw back onto the pump and tighten securely. To order a ground wire and clamp order part number 222011.

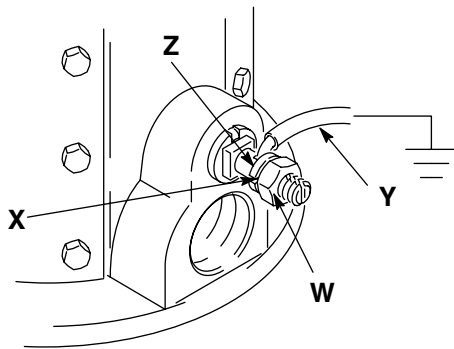

FIG. 1

Air and fluid hoses: use only electrically conductive hoses.

Air compressor: follow manufacturer's recommendations.

Dispense valve: ground through connection to a properly grounded fluid hose and pump.

Solvent pails used when flushing: follow local code. Use only conductive metal pails, placed on a grounded surface. Do not place the pail on a nonconductive surface, such as paper or cardboard, which interrupts grounding continuity.

Setup

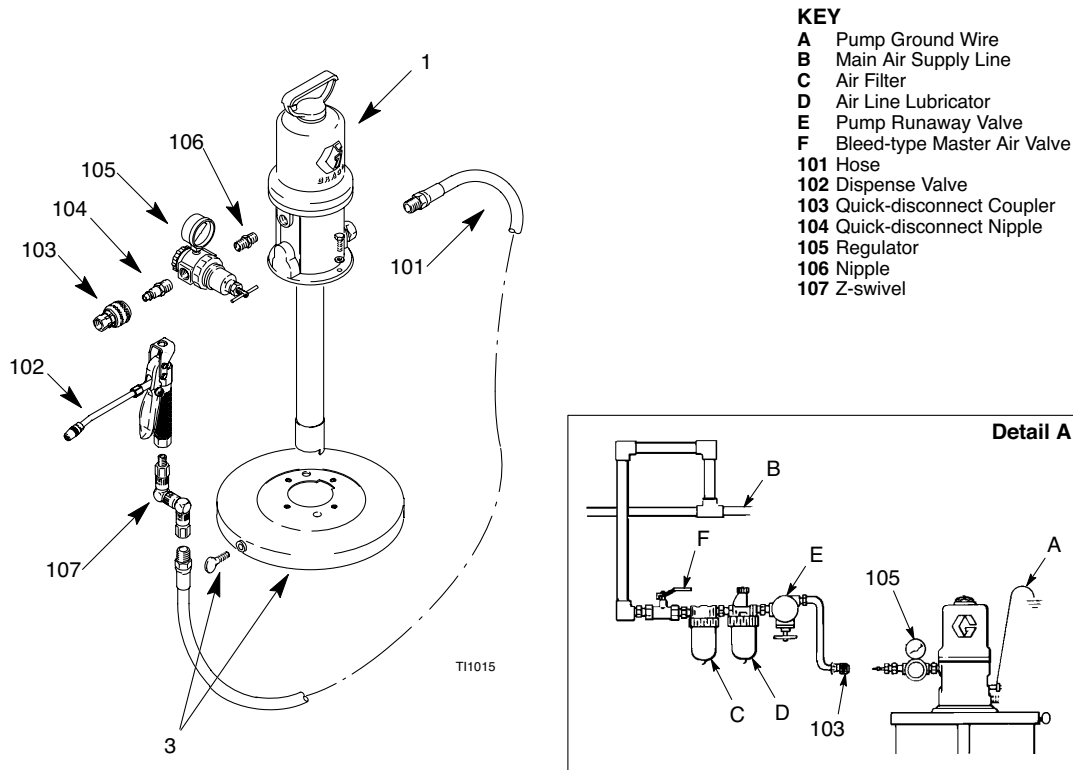

- KEY**
- A Pump Ground Wire
 - B Main Air Supply Line
 - C Air Filter
 - D Air Line Lubricator
 - E Pump Runaway Valve
 - F Bleed-type Master Air Valve
 - 101 Hose
 - 102 Dispense Valve
 - 103 Quick-disconnect Coupler
 - 104 Quick-disconnect Nipple
 - 105 Regulator
 - 106 Nipple
 - 107 Z-swivel

FIG. 2

For All Models

Assemble the air and fluid lines as shown in FIG. 2.

For Models 222078, 241043

Secure pump to cover (3) with the screws and lock washer provided. Position the assembly on an opened 35 lb pail. Tighten the thumbscrews, firmly.

For Models 220170, 241044

Secure cover (3) to opened fluid container with the thumbscrews provided. Insert the pump through the hole in the cover and lower it into the container. It is not necessary to bolt the pump to the cover.

For Models 220171, 241045

Set cover (3) on open drum. Thumbscrews are not required. Insert the pump through the hole in the cover and lower it into the drum. It is not necessary to bolt the pump to the air cover.

Air Line Accessories

Install the air line accessories in the order shown in FIG. 2. Detail A.

1. Install a bleed -type master air valve (F) to isolate the accessories for service.
2. Install an air line filter (C) to remove harmful dirt and contaminants from your compressed air supply.
3. Install an air line lubricator (D) for automatic air motor lubrication.
4. Install a pump runaway valve (E) to shut off the air to the pump if the pump accelerates beyond the pre adjusted setting. A pump which runs too fast can be seriously damaged.
5. Attach the quick disconnect coupler (103) to the air supply hose.

NOTICE

Avoid hanging the air accessories directly on the pump air inlet. The fittings are not strong enough to support the accessories and may cause one or more to break. If accessories must be installed directly on the pump, provide a bracket on which to mount the accessories.

CE Identification Label
(CE Marked Models Only)

To comply with CE directives, the CE identification label must be affixed to the pump near the pump identification label. Follow the label installation instructions included with the Kit. Use a permanent marker to record the installation date in the space provided and circle the part number on the label.

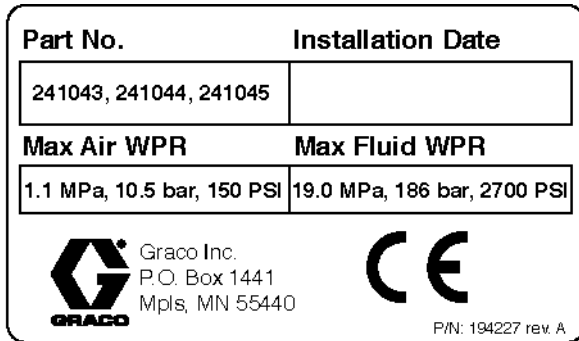





FIG. 3

Pressure Relief Procedure

						
Trapped air can cause the pump to cycle unexpectedly, which could result in serious injury from injection, splashing or moving parts. Relieve pressure when you stop pumping and before cleaning, checking or servicing equipment.						

1. Close the pump air regulator.
2. Close the pump's bleed-type master air valve (required in the system).
3. Hold a metal part of the dispense valve firmly to a grounded metal waste container and trigger to relieve fluid pressure.

*If you suspect that the dispensing valve is clogged, or that pressure has not been fully relieved after following the steps above, **very slowly** loosen the dispensing valve coupler or hose end coupling to relieve pressure gradually, then loosen completely. Then clear the clog.*

Operation

Start-up

Single or Multiple Pump Systems

1. Close the air regulators and bleed-type master air valves to all but one pump.
2. Open the master air valve from the compressor.
3. For the pump that is connected trigger the dispensing valve into a grounded metal waste container making firm metal-to-metal contact between the container and the valve. Open the bleed-type master air valve and open the pump air regulator slowly, just until the pump is running. When the pump is primed and all air has been pushed out of the lines, release the trigger.
4. If you have more than one pump, repeat this process for each pump.

NOTE: When the pump is primed and with sufficient air supplied, the pump starts when the dispensing valve is opened and shuts off when closed.

5. Set the air pressure to each pump at the lowest pressure needed to get the desired results.



The maximum working pressure of each pump in your system may not be the same. To reduce the risk of over-pressurizing any part of your system, be sure you know the maximum working pressure rating of each pump and its connected components. Never exceed the maximum working pressure of the lowest rated component connected to a particular pump.

To determine the fluid output pressure using the air regulator reading, multiply the ratio of the pump by the air pressure shown on the regulator gauge. For example:

10:(1) ratio x 100 psi air = 1000 psi fluid output

10:(1) ratio x 0.7 MPa air = 7 MPa fluid output

50:(1) ratio x 7 bar air = 70 bar fluid output

Limit the air to the pump so that no air line or fluid line component or accessory is over-pressurized.

NOTICE

Never allow the pump to run dry of the fluid being pumped. A dry pump will quickly accelerate to a high speed, possibly damaging itself. If your pump accelerates quickly, or is running too fast, stop it immediately and check the fluid supply. If the supply container is empty and air has been pumped into the lines, prime the pump and lines with fluid, or flush it and leave it filled with a compatible solvent. Be sure to eliminate all air from the fluid system.

NOTE: A pump runaway valve (E) can be installed on the air line to automatically shut off the pump if it starts to run too fast.

6. Read and follow the instructions supplied with each component in your system.



7. To shut off the system, always follow the **Pressure Relief Procedure**.

Parts

Models 222078, 241043

Ref.	No.	Part No.	Description	Qty.
	1	206405	PUMP, 15:1 Ratio Fire-Ball; see 306531 for parts	1
	2	222080	DISPENSE KIT, see parts (below)	1
	3	222058	COVER	1

CE Kit Parts 241168 - Model 241043

Ref	Part No.	Description	Qty
202	113286	VALVE, safety, 150 psi (1.0 MPA, 10.34 bar)	1
205	222011	CLAMP	1
208		LABEL, CE	1

Dispense Kit Model 222080

Ref.	No.	Part No.	Description	Qty.
	101	109165	HOSE, 3/8" ID, cpld 1/4 npt (mbe), 15 ft. (4.5 m)	1
	102	242056	VALVE, dispense	1
	103	110198	COUPLER, quick-disconnect, 3/8 npt (f)	1
	104	169971	NIPPLE, quick-disconnect	1
	105	110234	REGULATOR, air	1
	106	156849	NIPPLE, 3/8 npt	1
	107	202577	Z-SWIVEL	1

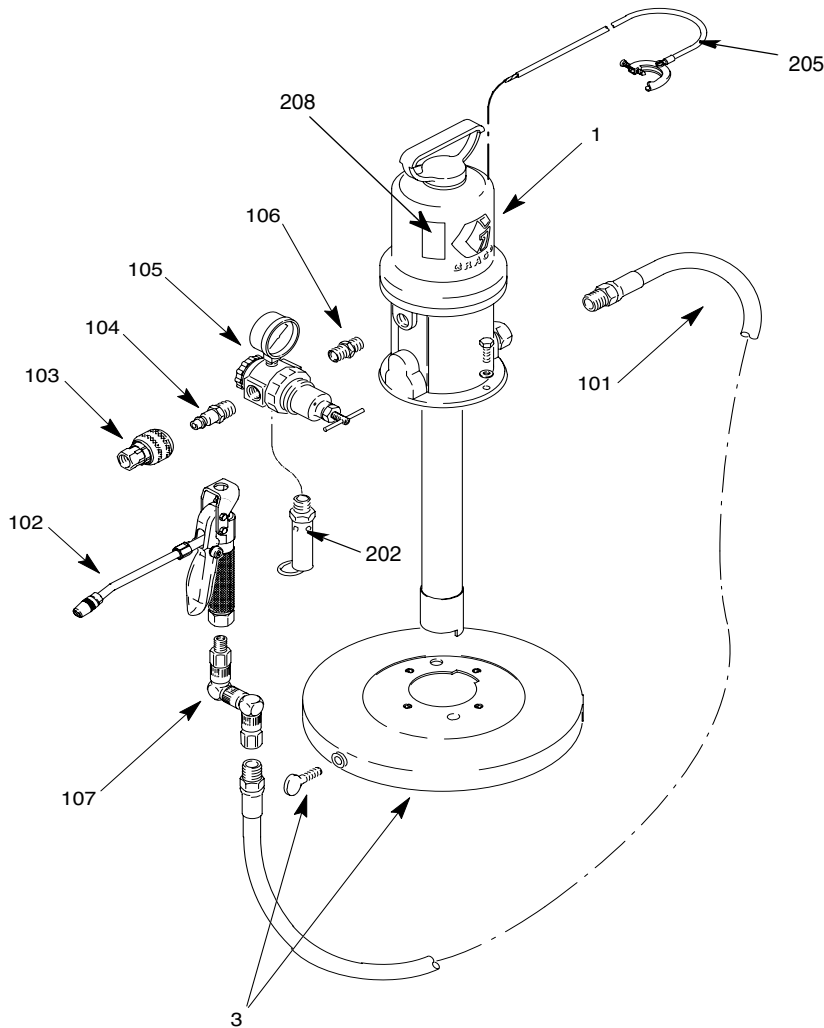

Models 220170, 241044

Ref. No.	Part No.	Description	Qty.
1	206699	PUMP, 15:1 Ratio Fire-Ball; see 306531 for parts	1
2	222081	DISPENSE KIT, see parts (below)	1
3	204574	COVER; see parts 306345	1

Dispense Kit Model 222081

Ref. No.	Part No.	Description	Qty.
101	109167	HOSE, 3/8" ID, cpld 1/4 npt (mbe), 25 ft. 7.6 m)	1
102	242056	VALVE, dispense	1
103	110198	COUPLER, quick-disconnect, 3/8 npt (f)	1
104	169971	NIPPLE, quick-disconnect	1
105	110234	REGULATOR, air	1
106	156849	NIPPLE, 3/8 npt	1
107	202577	Z-SWIVEL	1

CE Kit Parts 241168 - Model 241044

Ref	Part No.	Description	Qty
202	113286	VALVE, safety, 150 psi (1.0 MPA, 10.34 bar)	1
205	222011	CLAMP	1
208		LABEL, CE	1

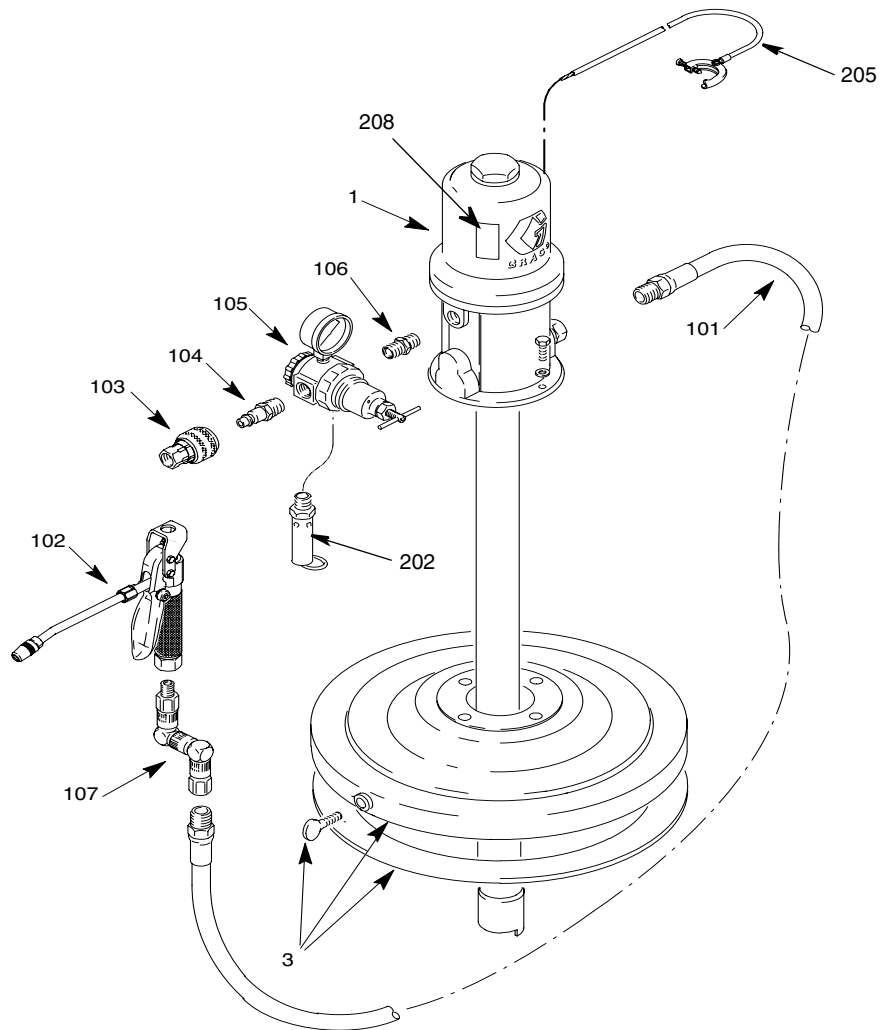

Models 220171, 241045

Ref. No.	Part No.	Description	Qty.
1	206700	PUMP, 15:1 Ratio Fire-Ball; see 306531 for parts	1
2	222081	DISPENSE KIT, see parts (below)	1
3	200326	COVER; see parts 306345	1

Dispense Kit Model 222081

Ref. No.	Part No.	Description	Qty.
101	109167	HOSE, 3/8" ID, cpld 1/4 npt (mbe), 25 ft. 7.6 m)	1
102	242056	VALVE, dispense	1
103	110198	COUPLER, quick-disconnect, 3/8 npt (f)	1
104	169971	NIPPLE, quick-disconnect	1
105	110234	REGULATOR, air	1
106	156849	NIPPLE, 3/8 npt	1
107	202577	Z-SWIVEL	1

CE Kit Parts 241168 - Model 241045

Ref	Part No.	Description	Qty
202	113286	VALVE, safety, 150 psi (1.0 MPA, 10.34 bar)	1
205	222011	CLAMP	1
208		LABEL, CE	1

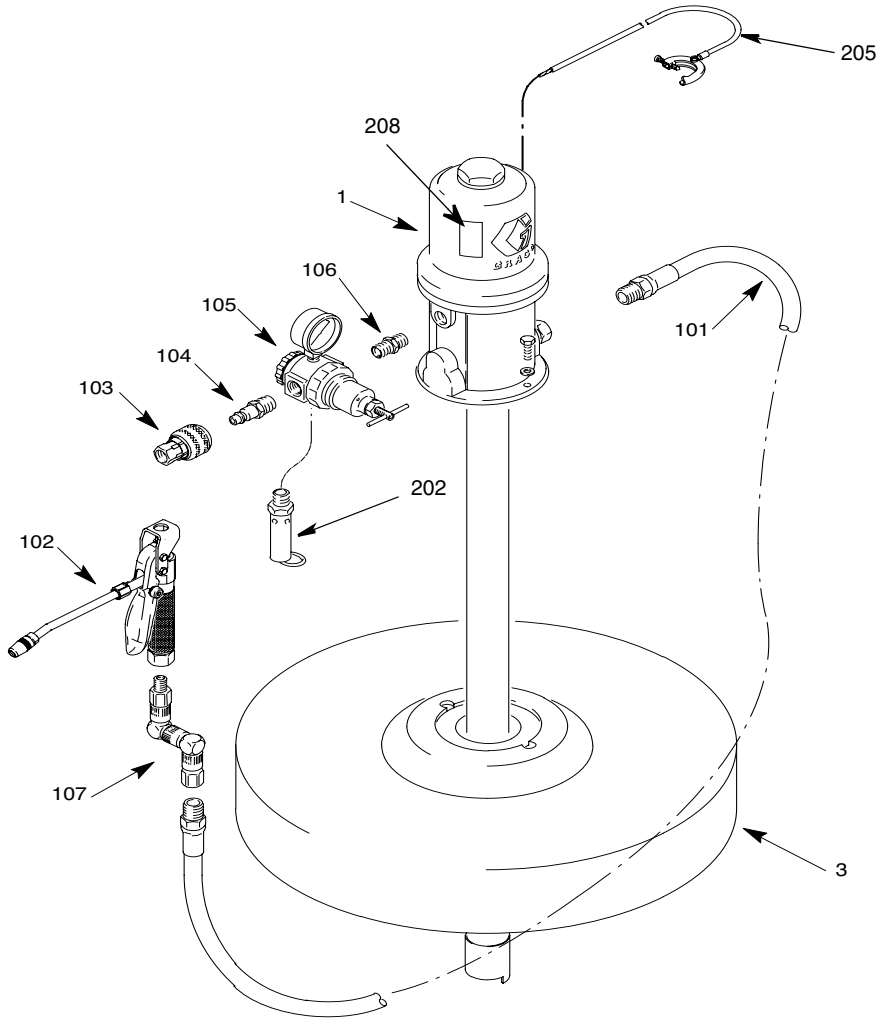

Graco Standard Warranty

Graco warrants all equipment referenced in this document which is manufactured by Graco and bearing its name to be free from defects in material and workmanship on the date of sale to the original purchaser for use. With the exception of any special, extended, or limited warranty published by Graco, Graco will, for a period of twelve months from the date of sale, repair or replace any part of the equipment determined by Graco to be defective. This warranty applies only when the equipment is installed, operated and maintained in accordance with Graco's written recommendations.

This warranty does not cover, and Graco shall not be liable for general wear and tear, or any malfunction, damage or wear caused by faulty installation, misapplication, abrasion, corrosion, inadequate or improper maintenance, negligence, accident, tampering, or substitution of non-Graco component parts. Nor shall Graco be liable for malfunction, damage or wear caused by the incompatibility of Graco equipment with structures, accessories, equipment or materials not supplied by Graco, or the improper design, manufacture, installation, operation or maintenance of structures, accessories, equipment or materials not supplied by Graco.

This warranty is conditioned upon the prepaid return of the equipment claimed to be defective to an authorized Graco distributor for verification of the claimed defect. If the claimed defect is verified, Graco will repair or replace free of charge any defective parts. The equipment will be returned to the original purchaser transportation prepaid. If inspection of the equipment does not disclose any defect in material or workmanship, repairs will be made at a reasonable charge, which charges may include the costs of parts, labor, and transportation.

THIS WARRANTY IS EXCLUSIVE, AND IS IN LIEU OF ANY OTHER WARRANTIES, EXPRESS OR IMPLIED, INCLUDING BUT NOT LIMITED TO WARRANTY OF MERCHANTABILITY OR WARRANTY OF FITNESS FOR A PARTICULAR PURPOSE.

Graco's sole obligation and buyer's sole remedy for any breach of warranty shall be as set forth above. The buyer agrees that no other remedy (including, but not limited to, incidental or consequential damages for lost profits, lost sales, injury to person or property, or any other incidental or consequential loss) shall be available. Any action for breach of warranty must be brought within two (2) years of the date of sale.

GRACO MAKES NO WARRANTY, AND DISCLAIMS ALL IMPLIED WARRANTIES OF MERCHANTABILITY AND FITNESS FOR A PARTICULAR PURPOSE, IN CONNECTION WITH ACCESSORIES, EQUIPMENT, MATERIALS OR COMPONENTS SOLD BUT NOT MANUFACTURED BY GRACO. These items sold, but not manufactured by Graco (such as electric motors, switches, hose, etc.), are subject to the warranty, if any, of their manufacturer. Graco will provide purchaser with reasonable assistance in making any claim for breach of these warranties.

In no event will Graco be liable for indirect, incidental, special or consequential damages resulting from Graco supplying equipment hereunder, or the furnishing, performance, or use of any products or other goods sold hereto, whether due to a breach of contract, breach of warranty, the negligence of Graco, or otherwise.

FOR GRACO CANADA CUSTOMERS

The Parties acknowledge that they have required that the present document, as well as all documents, notices and legal proceedings entered into, given or instituted pursuant hereto or relating directly or indirectly hereto, be drawn up in English. Les parties reconnaissent avoir convenu que la rédaction du présente document sera en Anglais, ainsi que tous documents, avis et procédures judiciaires exécutés, donnés ou intentés, à la suite de ou en rapport, directement ou indirectement, avec les procédures concernées.

Graco Information

For the latest information about Graco products, visit www.graco.com.

TO PLACE AN ORDER, contact your Graco distributor or call to identify the nearest distributor.

Phone: 612-623-6921 **or Toll Free:** 1-800-328-0211 **Fax:** 612-378-3505

*All written and visual data contained in this document reflects the latest product information available at the time of publication.
Graco reserves the right to make changes at any time without notice.*

Original instructions. This manual contains English. MM 307882

Graco Headquarters: Minneapolis

International Offices: Belgium, China, Japan, Korea

GRACO INC. AND SUBSIDIARIES • P.O. BOX 1441 • MINNEAPOLIS MN 55440-1441 • USA

Copyright 1998, Graco Inc. All Graco manufacturing locations are registered to ISO 9001.

www.graco.com

Revised 1/2012