

Fire-Ball® Oil Pumps

309869C

For non-corrosive and non-abrasive oils and lubricants only.

Mini Fire-Ball 225, 3:1 Bare Oil Pump, Part 246775

540 psi (3.7 MPa, 37 bar) Maximum Working Pressure

180 psi (1.24 MPa, 12.4 bar) Maximum Air Input Pressure

Fire-Ball 300, 5:1, Bare Oil Pump, Part 203876

900 psi (6.2 MPa, 62 bar) Maximum Working Pressure

180 psi (1.24 MPa, 12.4 bar) Maximum Air Input Pressure

Fire-Ball 425, 3:1, Bare Oil Pump, Part 237526

540 psi (3.7 MPa, 37 bar) Maximum Working Pressure

180 psi (1.24 MPa, 12.4 bar) Maximum Air Input Pressure

Fire-Ball 425, 6:1, Bare Oil Pump, Part 238108

1100 psi (7.6 MPa, 76 bar) Maximum Working Pressure

180 psi (1.24 MPa, 12.4 bar) Maximum Air Input Pressure

Fire-Ball 425, 10:1, Bare Oil Pump, Part 205626

1800 psi (12.4 MPa, 124 bar) Maximum Working Pressure

180 psi (1.24 MPa, 12.4 bar) Maximum Air Input Pressure

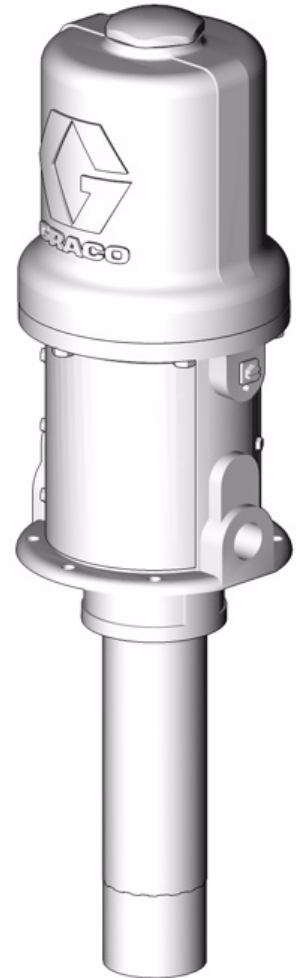

Important Safety Instructions

Read all warnings and instructions in this manual.
Save these instructions.

Parts/Materials required	See page 5
Time required to rebuild pump	1 hour

PROVEN QUALITY. LEADING TECHNOLOGY.

Contents

Interactive Manual	2	Part 205626, 425 (10:1) Pump Parts List	43
Manual Conventions	3	225 (3:1) Technical Data	44
Before you start	5	225 (3:1) Performance Chart	44
Pressure Relief Procedure	6	300 (5:1) Technical Data	45
Service and Repair	7	300 (5:1) Performance Chart	45
Cleaning and Servicing	21	425 (3:1) Technical Data	46
Reassembly	22	425 (3:1) Performance Chart	46
Reinstalling the Fire-Ball Pump	34	425 (6:1) Technical Data	47
Troubleshooting	35	425 (6:1) Performance Chart Flow	47
Air Motor and Pump Lower	38	425 (10:1) Performance Chart	48
Part 246775, 225 Mini-Fire-Ball Pump Parts	39	Notes	49
Part 203876, 300 Pump Parts List	40	Graco Standard Warranty	50
Part 237526, 425 (3:1) Pump Parts List	41		
Part 238108, 425 (6:1) Pump Parts List	42		

Interactive Manual

This manual was designed to be viewed on a computer. The computer version has short videos and animations built into the repair steps to provide you with a better understanding of how the Fire-Ball pump operates and demonstrates some of the repair steps. Click on this movie projector symbol in the instruction manual to see a short video or animation.



When using Adobe Acrobat, use the arrows circled in red to individually page through the manual or return directly to the beginning or end page. See FIG. 1. Use the arrows circled in blue when using the navigational links found in the manual. The arrow pointing left returns the reader to the previous page containing the link. Please install Windows Media Player to view the videos and animations.

Please contact your Graco distributor to obtain a CD that has the interactive additional reference materials. Movie icons do not appear in the printed manual. A printed copy of this manual can be obtained from the interactive CD, Graco's web site at www.graco.com, or by calling the 1-800 toll free number on the back of any instruction manual.



FIG. 1



Additional Reference Materials

309868	Installation, Operation Instructions, and Model Information

This manual was designed for those that have previous experience with Graco Fire-Ball pumps. If more detailed information is required please contact your local Graco distributor or visit Graco's web site at www.graco.com.

Manual Conventions

Warning



 WARNING  
<p>A warning alerts you to possible serious injury or death if you do not follow instructions.</p> <p>Symbols, such as fire and explosion (shown), alert you to a specific hazard and direct you to read the indicated hazard warnings beginning on page 3.</p>

Caution







CAUTION
<p>A caution alerts you to possible equipment damage or destruction if you do not follow instructions.</p>

Note

 A note indicates additional helpful information.

	WARNINGS
	<p>EQUIPMENT MISUSE HAZARD</p> <p>Misuse can cause death or serious injury.</p> <ul style="list-style-type: none"> • Do not exceed the maximum working pressure or temperature rating of the lowest rated system component. See Technical Data in all equipment manuals. • Use fluids and solvents that are compatible with equipment wetted parts. See Technical Data in all equipment manuals. Read fluid and solvent manufacturer's warnings. • Check equipment daily. Repair or replace worn or damaged parts immediately. • Do not alter or modify equipment. • Use equipment only for its intended purpose. Call your Graco distributor for information. • For professional use only. • Route hoses and cables away from traffic areas, sharp edges, moving parts, and hot surfaces. • Do not use hoses to pull equipment. • Comply with all applicable safety regulations.
	<p>PRESSURIZED EQUIPMENT HAZARD</p> <p>Fluid from the gun/dispense valve, leaks, or ruptured components can splash in the eyes or on skin and cause serious injury.</p> <ul style="list-style-type: none"> • Follow Pressure Relief Procedure in this manual, when you stop spraying and before cleaning, checking, or servicing equipment. • Tighten all fluid connections before operating the equipment. • Check hoses, tubes, and couplings daily. Replace worn or damaged parts immediately.

WARNING



 	<p>SKIN INJECTION HAZARD</p> <p>High-pressure fluid from gun, hose leaks, or ruptured components will pierce skin. This may look like just a cut, but it is a serious injury that can result in amputation. Get immediate surgical treatment.</p> <ul style="list-style-type: none"> • Do not point gun at anyone or at any part of the body. • Do not put your hand over the spray tip. • Do not stop or deflect leaks with your hand, body, glove, or rag. • Do not spray without tip guard and trigger guard installed. • Engage trigger lock when not spraying. • Follow Pressure Relief Procedure in this manual, when you stop spraying and before cleaning, checking, or servicing equipment.
	<p>MOVING PARTS HAZARD</p> <p>Moving parts can pinch or amputate fingers and other body parts.</p> <ul style="list-style-type: none"> • Keep clear of moving parts. • Do not operate equipment with protective guards or covers removed. • Pressurized equipment can start without warning. Before checking, moving, or servicing equipment, follow the Pressure Relief Procedure in this manual. Disconnect power or air supply.
	<p>TOXIC FLUID OR FUMES HAZARD</p> <p>Toxic fluids or fumes can cause serious injury or death if splashed in the eyes or on skin, inhaled, or swallowed.</p> <ul style="list-style-type: none"> • Read MSDS's to know the specific hazards of the fluids you are using. • Store hazardous fluid in approved containers, and dispose of it according to applicable guidelines.
 	<p>FIRE AND EXPLOSION HAZARD</p> <p>Flammable fumes, such as solvent and paint fumes, in work area can ignite or explode. To help prevent fire and explosion:</p> <ul style="list-style-type: none"> • Use equipment only in well ventilated area. • Eliminate all ignition sources; such as pilot lights, cigarettes, portable electric lamps, and plastic drop cloths (potential static arc). • Keep work area free of debris, including solvent, rags and gasoline. • Do not plug or unplug power cords or turn lights on or off when flammable fumes are present. • Ground equipment and conductive objects. See Grounding instructions. • Use only grounded hoses. • Hold gun firmly to side of grounded pail when triggering into pail. • If there is static sparking or you feel a shock, stop operation immediately. Do not use equipment until you identify and correct the problem.

Before you start

If you are unfamiliar with the Fire-Ball pump there are several resources that can be reviewed prior to rebuilding this pump. They include the training guides which provide theory and understanding of how the Fire-Ball pumps work. Refer to www.graco.com for additional information.

You must have the following tools and repair kit prior to rebuilding or repairing the Fire-Ball pump. Order repair kits and special tools from Graco Inc.

- Utility Knife
- Straight Blade Screwdriver or nut driver
- Crescent Wrench
- 1 Gallon Bucket
- Large Vise

<p>Model 225 Use adjustment tool, part# 15E796. 15E796 is also included in Repair Kit 246918.</p> <p>Models 300 and 425 Use adjustment tool, part# 171818.</p>	
<p>Model 225 Use pliers tool, part# 248198.</p> <p>Models 300 and 425 Use pliers tool, part# 207579.</p>	
<p>Repair Kits</p> <p>Model 225 (3:1) Repair Kit #246918 for both motor and lower repair.</p> <p>Model 300 (5:1) Repair Kit #238286 for both motor and lower repair.</p> <p>Model 425 (3:1) Repair Kit #207385 for air motor repair Repair Kit #237602 for lower repair</p> <p>Model 425 (6:1) Repair Kit #207385 for air motor repair Repair Kit #238225 for lower repair</p> <p>Model 425 (10:1) Repair Kit #238751 for both motor and lower repair.</p>	

Pressure Relief Procedure

WARNING

This equipment stays pressurized until pressure is manually relieved. Read PRESURIZED EQUIPMENT HAZARD warnings beginning on [page 3](#).

1. Close the pump air regulator (C) and the bleed-type master air valve (A) (required in your system).

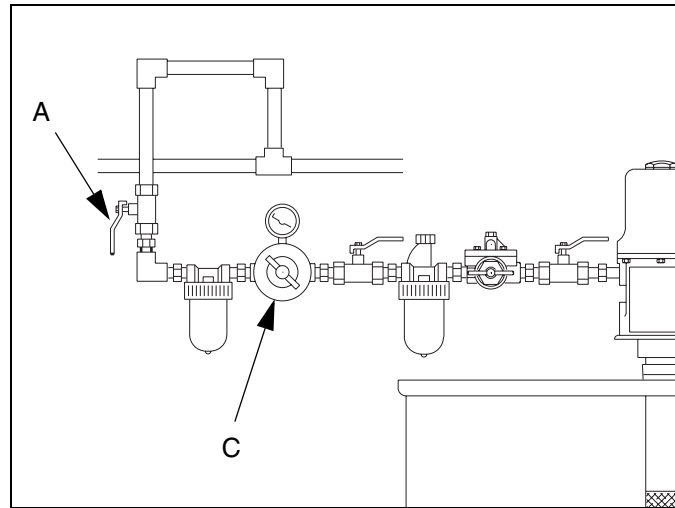

2. Hold a metal part of the dispensing valve (J) firmly to a grounded metal waste container, and trigger the valve to relieve the fluid pressure.

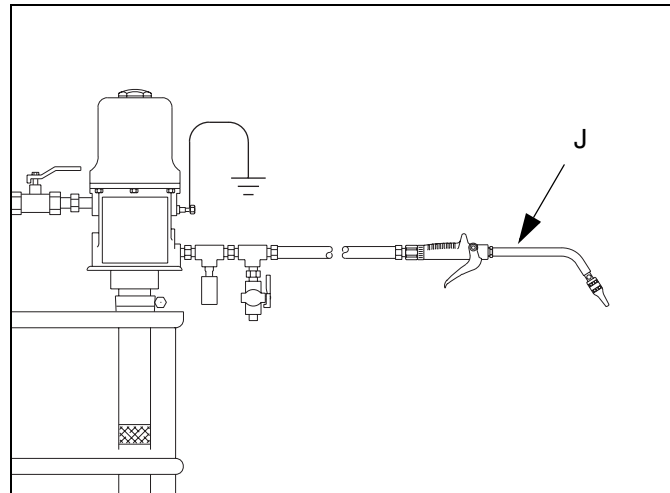

Service and Repair

WARNING						
						
Read warnings beginning on page 3 .						

Prior to rebuilding the pump remove it from production. To do this:

1. Flush the pump, and relieve the pressure. Follow the pressure relief procedure on [page 6](#).
2. Disconnect the ground wire from the ground screw (14) if equipped.
3. Disconnect any hoses.
4. Remove the pump from its mounting.

Disassembly

1. Vertically clamp the valve housing (42) in a vise and use a strap wrench or chain wrench to loosen the valve housing by turning the fluid cylinder (41).

CAUTION
Do not remove the valve housing (42). It is needed to support the removal of the fluid cylinder.

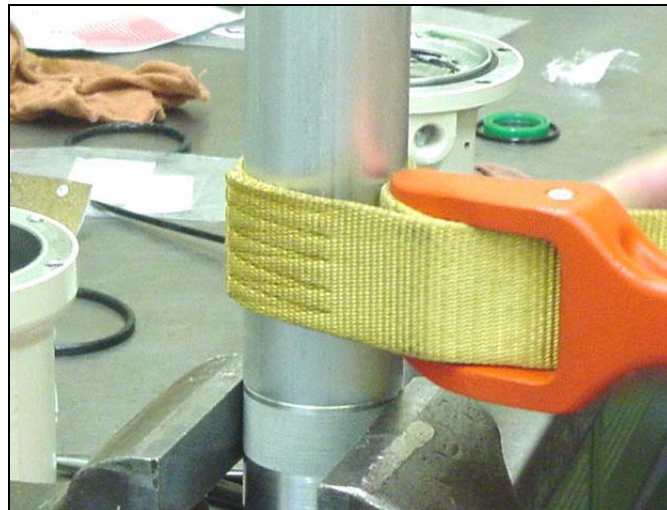

2. Horizontally clamp the air motor base (28) in a vise by closing the vise jaws on the air motor flange.



3. Use a strap wrench or chain wrench on the fluid cylinder (41) to screw it out of the air motor base (28).



4. Pull the fluid cylinder (41) off.



5. Remove the valve housing (42).



6. Remove ball retainer and inspect the metallic ball (8), ball retainer (44), and seat of valve housing (42) for damage.



7. Remove and replace the o-ring packing (21*).



8. Screw the valve housing (42) into the fluid cylinder (41) and hand tighten.



9. Pull the displacement rod (29) down.



10. Using wrenches on the flats of the displacement rod (29) and on the flats of the fluid piston (43), unscrew the fluid piston from the displacement rod.



11. Remove the metallic ball (6) from the end of the displacement rod (29).

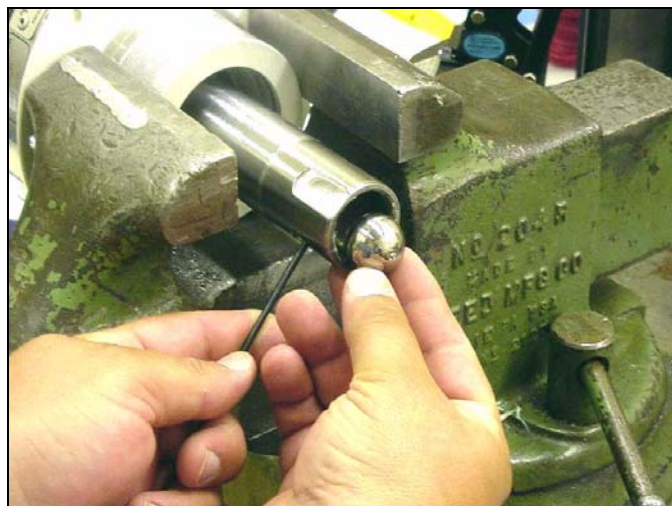

12. Remove the packing o-ring (11*) from the fluid piston (43).



13. Unscrew the cylinder cap nut (39) from the top of the air motor cylinder (35).

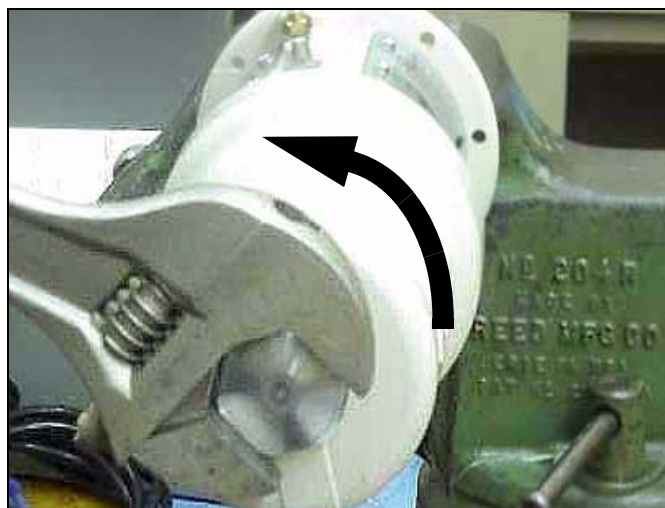

14. Pull up on the cylinder cap nut (39) to expose the trip rod (40).



15. Grasp the trip rod (40) with padded pliers. See page 5 for part numbers.

CAUTION

Do not damage the plated surface of the trip rod (40). Damaging the surface of the trip rod can result in erratic motor operation.



16. Unscrew the cylinder cap nut (39) from the trip rod (40).



17. Thread the service nut (A) (not supplied) onto the top of the trip rod (40).

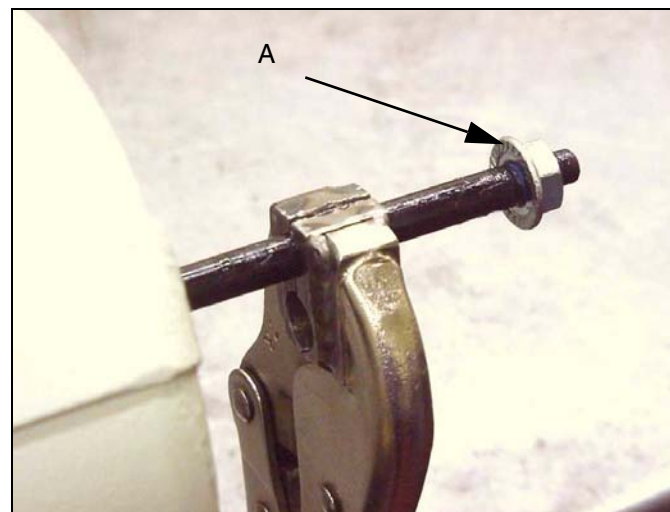

18. Remove the six hex head screws (7) holding the air motor plate identification (46) to the air motor base (28).



19. Remove the six hex head screws (7) holding the warning plate (47) to the air motor base (28).



20. Remove the six hex head cap screws (9) holding the air motor cylinder (35) to the air motor base (28).



21. Carefully pull the air motor cylinder (35) straight off of the air motor piston (34).

CAUTION

To avoid damaging the cylinder wall, pull the cylinder straight off of the piston. Never tilt the cylinder while you are removing it.

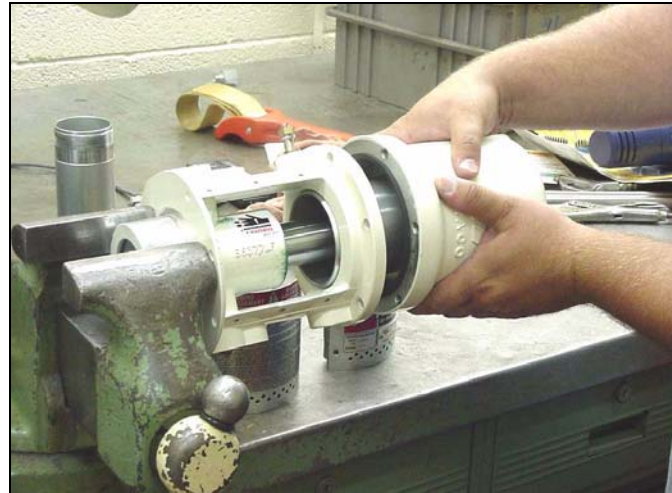

22. Pull the air motor piston/displacement rod assembly (34, 29) clear of the air motor base (28).



23. Remove o-ring packing (12*).

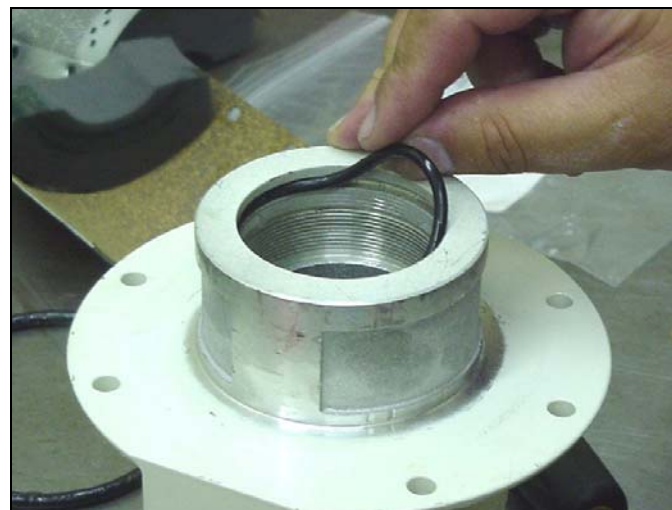

24. Remove the block packing (16*) from the bottom of the air motor base (28).



25. Remove the o-ring packing (13*) from the air motor base.



26. Clamp the air motor piston (34) in an upright position.



27. Remove the o-ring packing (18*) from the air motor piston (34).

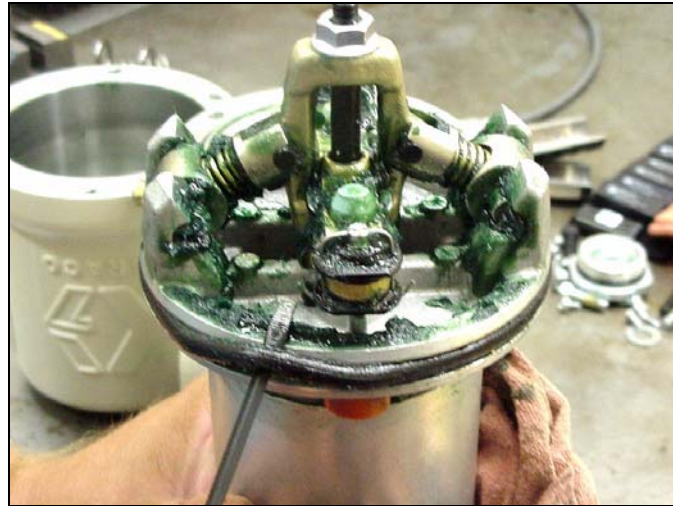

28. Use a screwdriver handle to push down the trip rod yoke (23) to snap the toggle arms (38) down.



⚠ WARNING



To reduce the risk of pinching or amputating your fingers, always keep fingers clear of the toggle assemblies. Read warnings beginning on [page 3](#).

29. Place an adjustable wrench on top of the toggle arms (38) and push down to compress the spring and release from the piston lug.



30. Swing the toggle assembly up and away from the piston lugs, and remove the assembly.



31. Remove the toggle pins (36) from the trip rod yoke (23).



32. Straighten the lockwires (25*).



33. Remove the lockwires (25*) from the valve nuts (24*).



34. Screw the top valve nuts off (24*).



35. Pull the valve assembly out of the piston.



36. Remove the trip rod (40), trip rod yoke (23), and valve actuator (27).



37. To remove the valve poppets (31*) cut them with a sharp knife or side cutter.



38. To remove the lower valve grommets (17*) cut them off with a sharp knife or cutter.



39. Unscrew and remove the bottom valve nuts (24*) and the poppet valve (32).

Disassembly is complete.



Cleaning and Servicing

⚠ WARNING



Read warnings beginning on [page 3](#).

1. Clean all the parts carefully in a compatible solvent and inspect for wear or damage. Use all the repair kit parts during reassembly, and replace other parts as necessary.



2. Check the polished surfaces of the air motor piston (34), displacement rod (29) and air motor cylinder (35) wall for scratches or wear. A scored rod will cause premature packing wear and leaking.



3. Lubricate all parts with a light weight, water-resistant grease.

CAUTION

When reassembling be sure that all moving parts are greased thoroughly to prevent unnecessary wear.



Reassembly

CAUTION
When reassembling be sure that all moving parts are greased thoroughly to prevent unnecessary wear.

1. Clamp the displacement rod (29) upright in the vise by closing the vise jaws on the flats of the displacement rod.

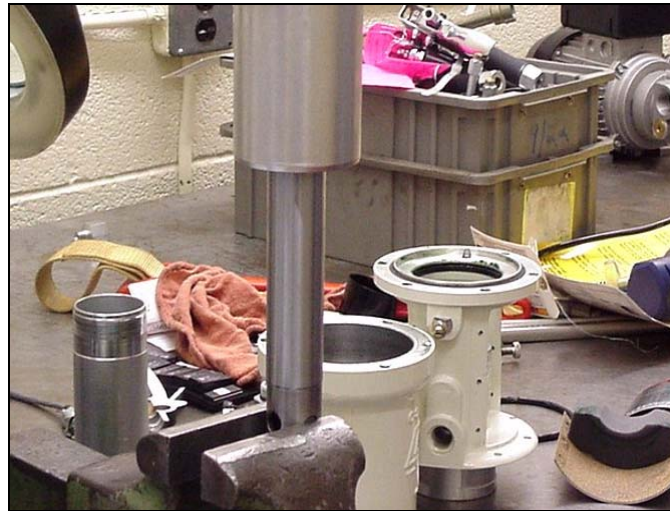

2. Install the new lower valve grommets (17*) in the valve actuator (27).



3. Pull the new poppet valves (31*) into the valve actuator (27).

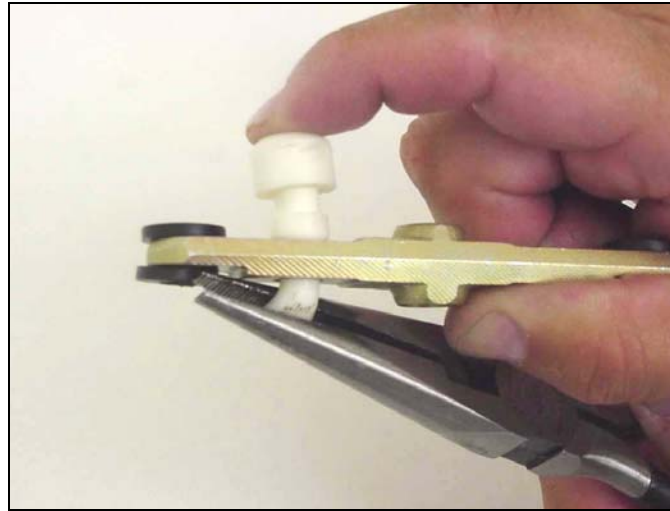

4. Clip off the top parts of the valve poppets (31*) shown with dotted lines.

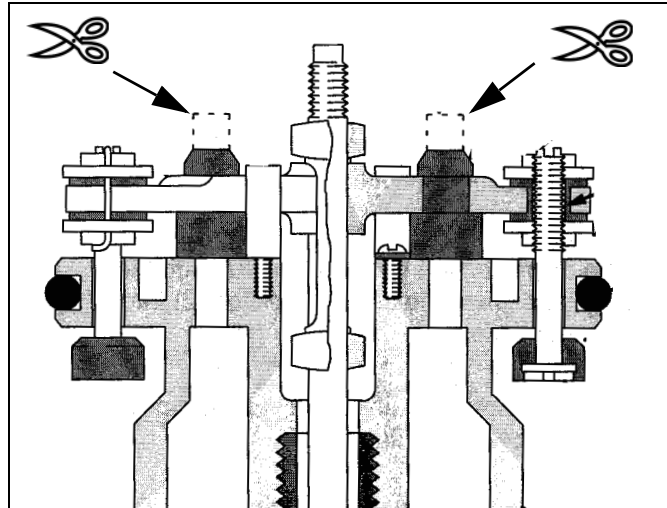

5. Place the poppet valves (32*) in the air motor piston (34).



6. Thread the bottom valve nuts (24*) onto the stems of the poppet valves until there are a few threads left before the threads run out.



If you thread the valve nuts too far down onto the poppet valves, they will run off of the threaded part.



7. Assemble the trip rod yoke (23) and actuator valve (27) and insert the trip rod (40).



8. Grease heavily and place the trip rod (40) into the air motor piston (34) with the stems of the poppet valves (32*) going through the lower valve grommets (17*).

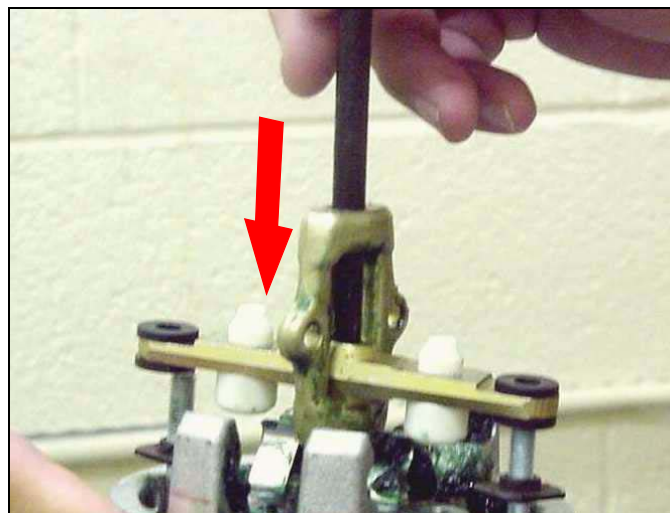

9. Check that the valve actuator (27) is aligned by the spring clips (26), and slides easily into them. Replace the spring clips (26) if worn or bent.



10. Thread the top valve nuts (24*) onto the stems of the poppet valves (32*) until snug.

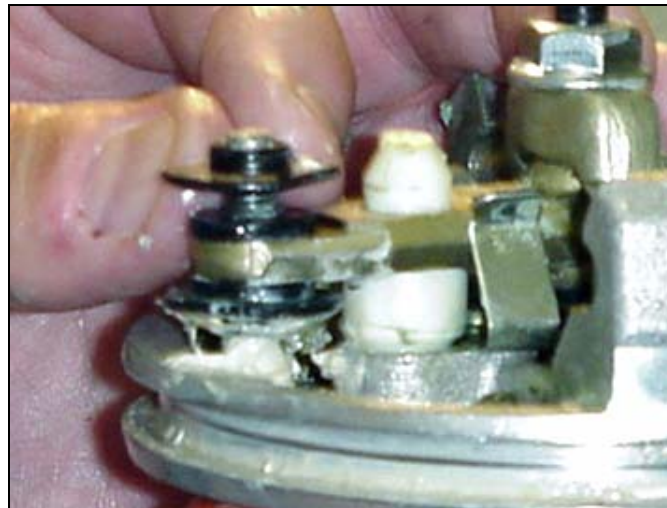

11. Install the toggle pins (36) in the trip rod yoke (23).



12. Place the toggle arm (38) ends of the toggle assembly onto the toggle pins (36), and snap the pivot pin ends of the toggle assembly into the piston lugs.

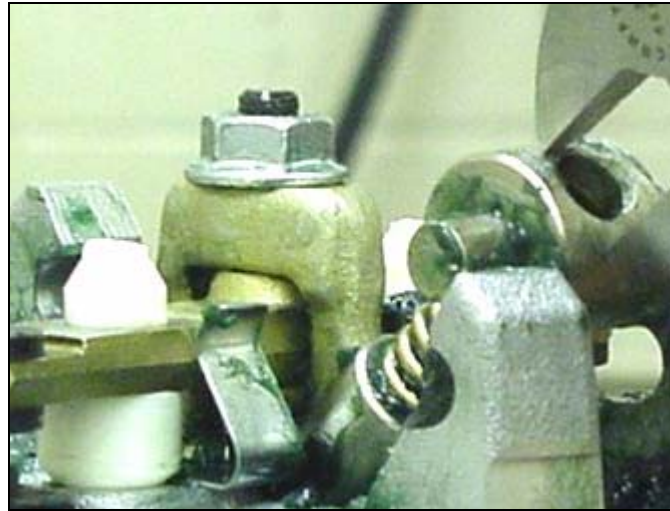

13. Set gap using the gap adjustment tool*.

*Use part no. 15E796, which is also included in Repair Kit 246918, for Mini Fire-Ball 225 pumps. Use part no. 171818 for all other Fire-Ball pump models.

 Adjust the distance between the inlet valve poppets and the piston seat by turning the top valve nuts (24*).

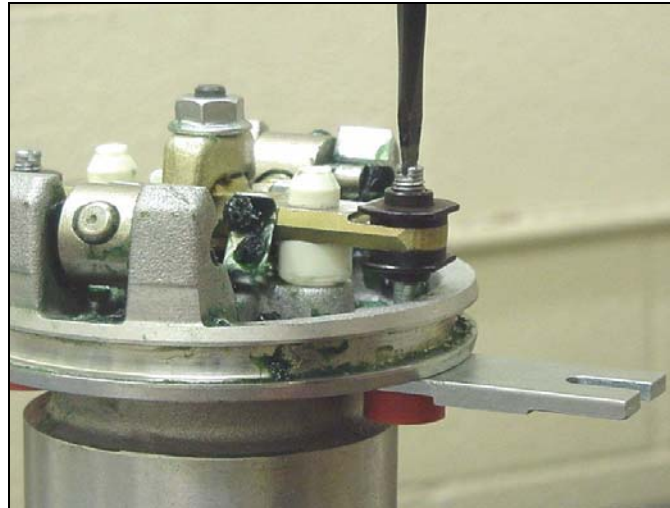

14. Tighten the bottom valve nuts (24*) very tight by hand. The lower valve grommets (17*) should be slightly compressed.



- Align the holes in the valve nuts (24*) and the slots on the stems of the poppet valves (32*) and install the lock wires (25*) through the holes in the top and bottom valve nuts. For more detail see FIG. 1, page 36.



- Pull the lock wires (25*) down tightly, and bend the ends out with pliers so that they cannot be pulled back out of the holes.

CAUTION
Never reuse the old lock wires. They will get brittle and break easily from too much bending.

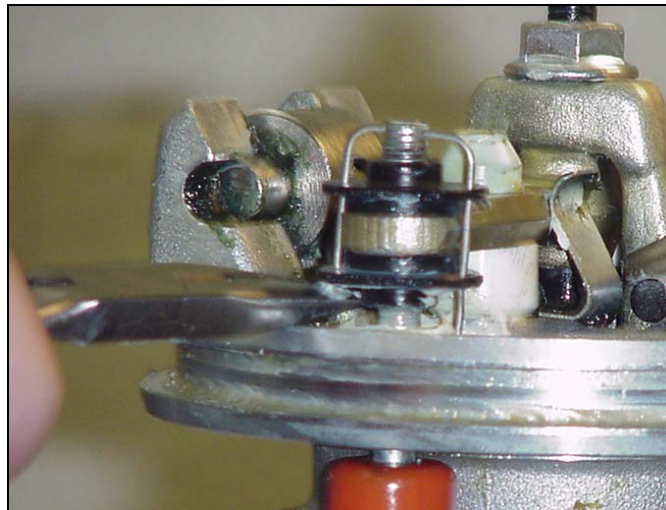

- Grease and install o-ring packing (18*).



18. Grease and install the new o-ring packing (13*).



19. Grease and install the new o-ring packing (12*).

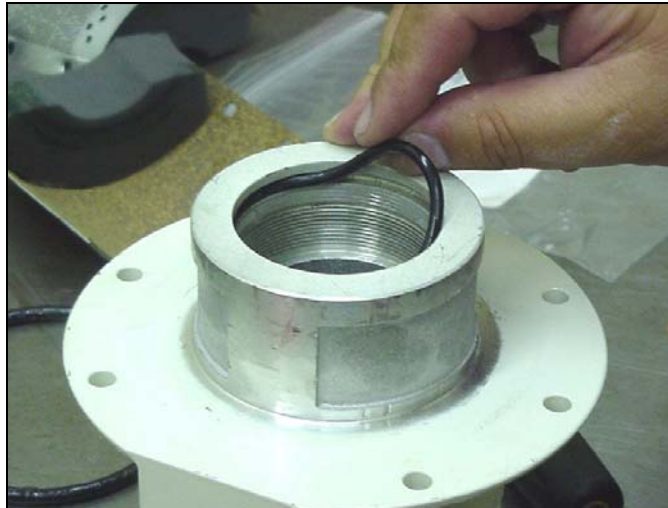

20. Install the new block packing (16*) through the bottom of the air motor base (28), with the lips facing toward the bottom of the pump.



21. Clamp the air motor base (28) in a vise by closing the vise jaws below the flange.



22. Grease the outside of the air motor piston (34) and displacement rod (29).



23. Slide the displacement rod (29) through the packings, and slide the air motor piston (34) into the air motor base (28).



24. Carefully slide the air motor cylinder (35) straight onto the air motor piston (24).

CAUTION
To avoid damaging the air motor cylinder wall, slide the cylinder straight onto the piston. Never tilt the cylinder while you are replacing it.

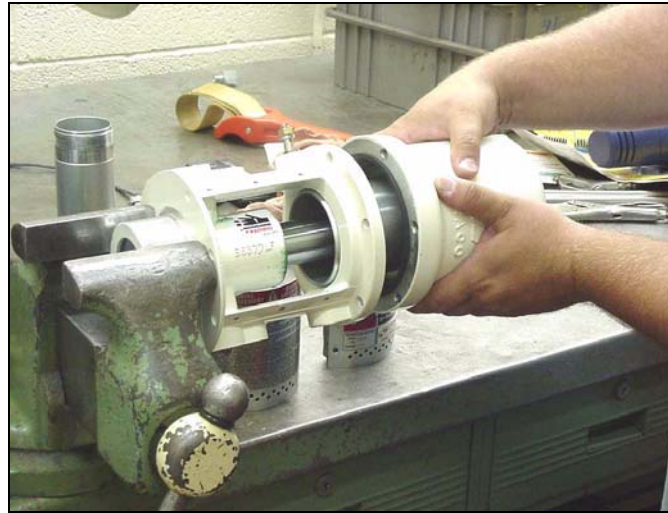

25. Replace the six button head screws (9) holding the air motor cylinder (35) to the air motor base (28).



26. Remove the nut (A) on the trip rod (40) and grip the trip rod with padded pliers (see page 5).

CAUTION
Do not damage the plated surface of the trip rod (40). Damaging the surface of the trip rod can result in erratic motor operation.

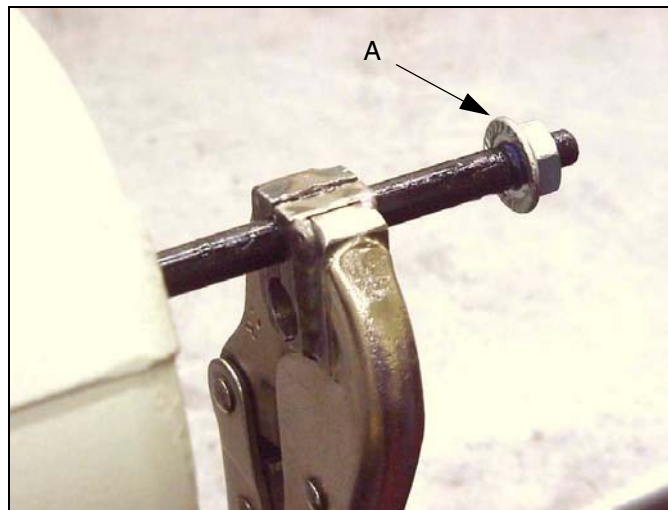

27. Tighten the cylinder cap nut (39).



28. Screw the cylinder cap (39) onto the top of the cylinder.

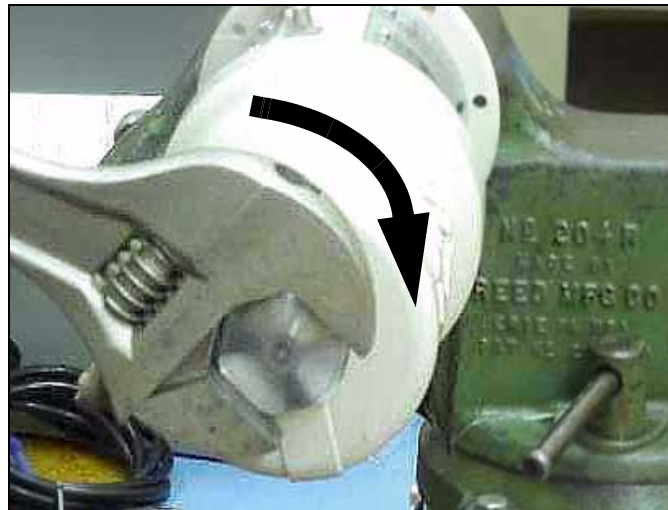

29. Replace the six hex head screws (7) holding the air motor plate identification (46) onto the air motor base (28).



30. Replace the six screws (7) holding the warning plate (47) onto the air motor base (28).



31. Place the ball (6) into the displacement rod (29).



32. Install the new o-ring packing (11*) onto the fluid piston.



33. Clean the threads of the fluid piston (43) and apply Loctite to the threads.

 Loctite will not work on oily threads. Be sure to clean threads.



34. Thread the fluid piston (43) onto the displacement rod (29). Torque to 40 to 60 ft-lb (54 to 81 N.m).

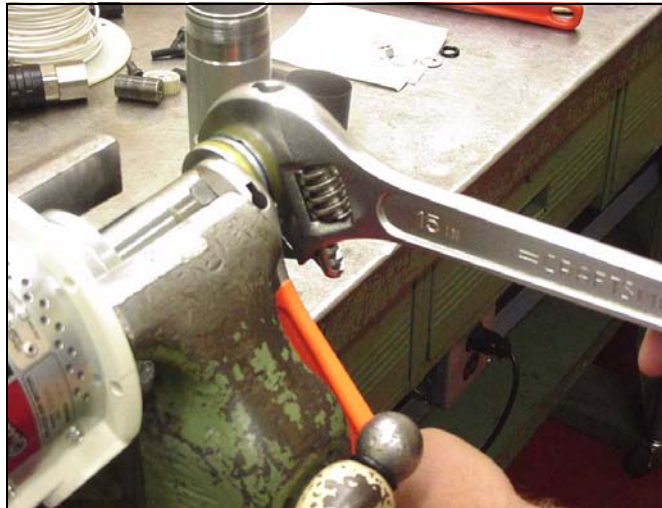

35. Replace the fluid cylinder (41) with valve housing (42) back into the air motor base (28). Torque to 40 to 60 ft-lb (54 to 81 N.m).

36. Using a strap wrench or chain wrench, torque the valve housing (42) to 40 to 60 ft-lb (54 to 81 N.m).



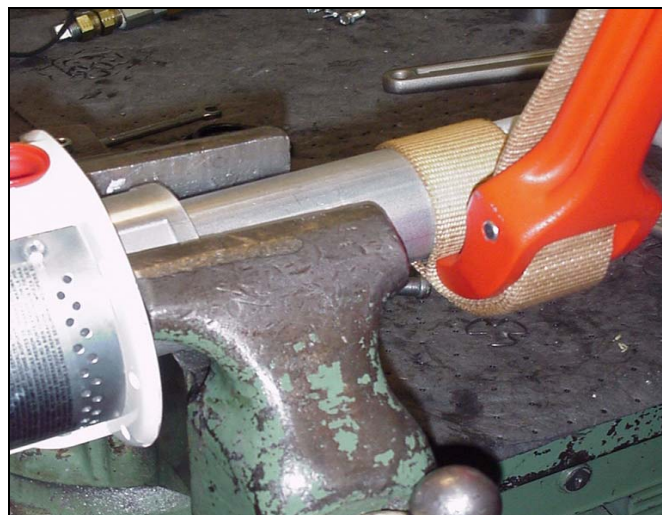



Assembly is complete.



Reinstalling the Fire-Ball Pump

Replacing the pump back into production.

 **WARNING**

Read warnings beginning on [page 3](#). Never operate the pump with the warning plates (47) or the identification plate (46) removed. These plates protect your fingers from getting pinched or amputated by moving parts in the air motor.

Before remounting the pump, connect an air hose and run the air motor slowly, starting with just enough air pressure to make the air motor run. Make sure that it operates smoothly.

1. Place the pump back into it's mounting.
2. Reconnect any hoses
3. Reconnect the ground wire from the ground screw ([14](#)).
4. Pressurize the pump.

Troubleshooting

 **WARNING**



Read warnings beginning on [page 3](#).

 Check all other possible problems and solutions before disassembling the pump. Before you troubleshoot problems using the table below, relieve the pressure and disconnect the pump fluid line. If the pump starts when the air is turned on again, the fluid line, dispensing valve, etc., is clogged.

Problem	Cause	Solution
Pump fails to operate	Inadequate air supply pressure or restricted air lines	Increase air supply; clear
	Closed or clogged dispensing valve	Open; clear
	Clogged fluid lines, hoses, valve, etc.	Clear
	Damaged air motor	Service air motor
	Exhausted fluid supply	Refill and reprime or flush
Continuous air exhaust	Worn or damaged air motor gasket, packing, seal, etc.	Service air motor
Erratic pump operation	Exhausted fluid supply	Refill and reprime or flush
Pump operates, but output low on down stroke	Held open or worn intake valve or piston packings	Clear; service
Pump operates, but output low on up stroke	Held open or worn piston ball or piston packings	Clear; service
Pump operates, but output low on both strokes	Inadequate air supply pressure or restricted air lines	Increase air supply; clear
	Closed or clogged valves	Open; clean
	Exhausted fluid supply	Refill and reprime or flush
	Clogged fluid lines, hoses, valves, etc.	Clear

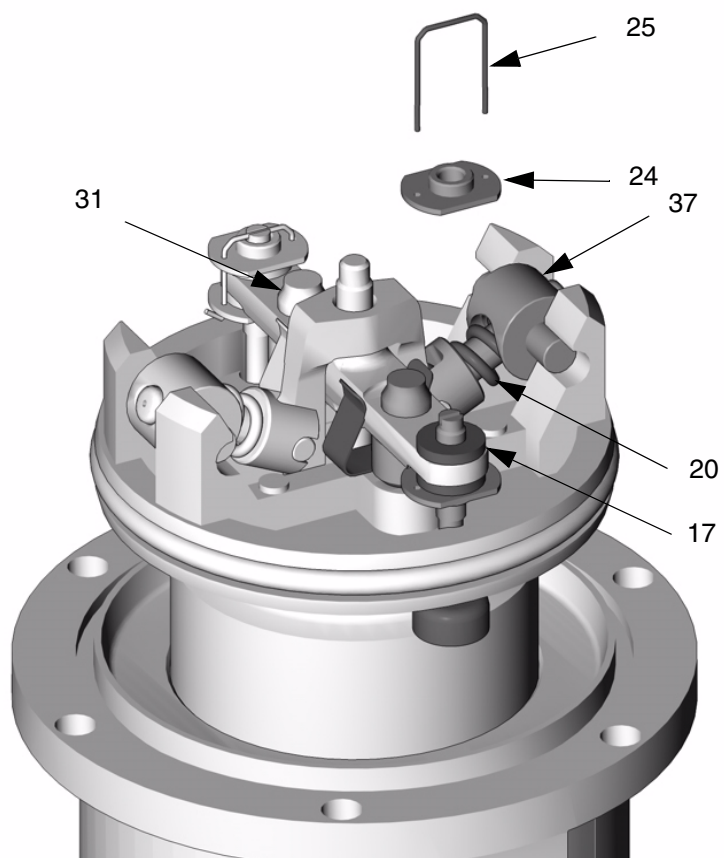
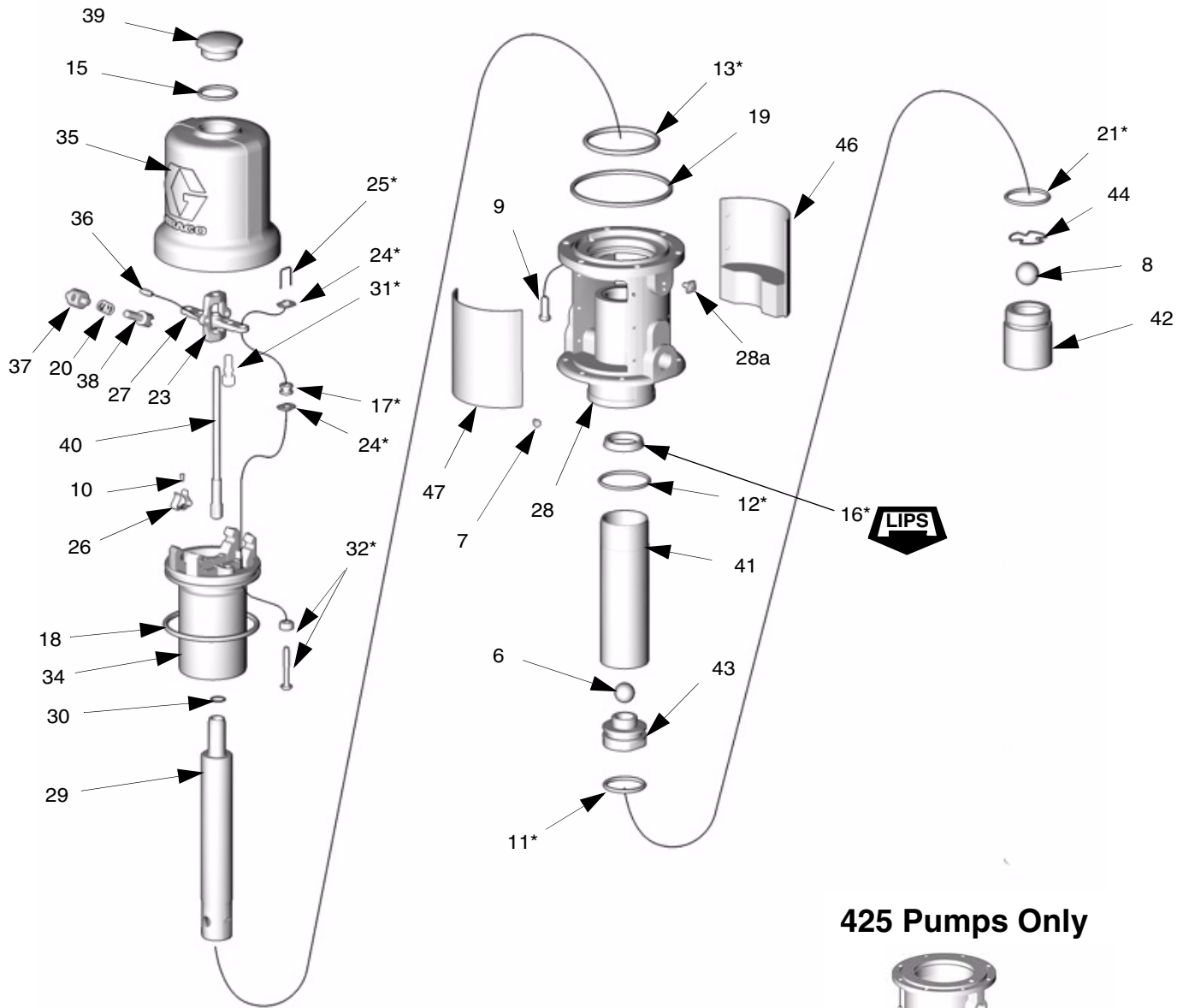

FIG. 1



A series of horizontal lines for writing, consisting of 16 evenly spaced lines spanning the width of the page.

Air Motor and Pump Lower



The 425 pump series has an air exhaust muffler (A) instead of muffler plates (46, 47) that Models 225 and 300 have. The 425 pump models also have a piston washer that Models 225 and 300 do not have. Order parts from the table below.

Ref No.	425 Pump 237526 (3:1)	425 Pump 238108 (6:1)	425 Pump 205626 (10:1)
A	102656	102656	102656
B	189711	190924	191123

425 Pumps Only

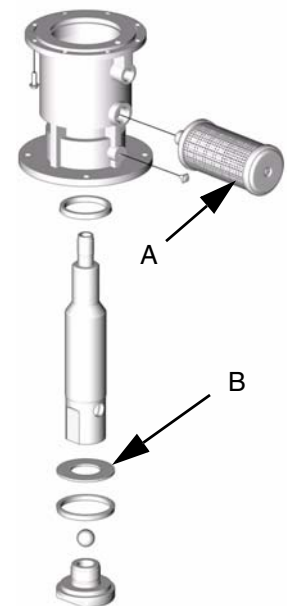

Part 246775, 225 Mini-Fire-Ball Pump Parts

Ref. No.	Part No.	Description	Qty.	Ref. No.	Part No.	Description	Qty.
6	100400	BALL, metallic	1	31*	15C267	POPPET, valve	2
7	100078	SCREW, thread forming, hex head	12	32*	248211	VALVE, poppet**	2
8	100279	BALL, metallic	1	34	15C270	PISTON, motor, air 2-1/4"	1
9	101578	SCREW, cap, hex head	6	35	15C274	CYLINDER, motor, air	1
10	118718	SCREW, machine	2	36	15C275	PIN, toggle	2
11*	107227	PACKING, o-ring	1	37	15C276	PIN, pivot	2
12*	107306	PACKING, o-ring	1	38	15C277	ARM, toggle	2
13*	113347	PACKING, o-ring	1	39	15C278	NUT, cap, cylinder	1
15	156698	PACKING, o-ring	1	40	15C279	ROD, trip	1
16*	118106	PACKING, block	1	41	15C499	CYLINDER, fluid	1
17*	118107	GROMMET, lower valve	2	42	15C500	HOUSING, valve	1
18*	118108	PACKING, o-ring	1	43	15C501	PISTON, fluid	1
19	118109	PACKING, square	1	44	15C533	RETAINER, ball	1
20	118111	SPRING, compression, helical	1	46	246782	PLATE, muffler, serial number	1
21*	157195	PACKING, o-ring	1	47	246783	PLATE, muffler, warning	1
23	15C245	YOKE, rod, trip	1				
24*	15C246	NUT, valve	4				
25*	15C247	WIRE, lock	2				
26	15C248	CLIP, spring	2				
27	15C249	ACUTATOR, valve	1				
28	253580	BASE, motor, air (includes 28a)	1				
28a	116343	SCREW, grounding	1				
29	15C252	ROD, displacement, mp	1				
30	15C266	GASKET, copper	1				

* Included in pump Repair Kit 246918

** Use gap adjustment tool [15E796](#) (also included in Repair Kit 246918) to ensure correct gap setting for poppets.

Part 203876, 300 Pump Parts List

Ref. No.	Part No.	Description	Qty.	Ref. No.	Part No.	Description	Qty.
6	100279	BALL, metallic	1	31*	170709	POPPET, valve	2
7**	100078	SCREW, thread forming, hex head	12	32*	236079	VALVE, poppet***	2
8	101190	BALL, metallic	1	34	160614	PISTON, motor, air	1
9	101578	SCREW, cap, hex head	6	35	160613	CYLINDER, motor, air	1
10	102975	SCREW, machine	2	36	158362	PIN, toggle	2
11*	113423	PACKING, o-ring	1	37	158364	PIN, pivot	2
12*	156641	PACKING, o-ring	1	38	160623	ARM, toggle	2
13*	160625	PACKING, o-ring	1	39	161435	NUT, cap, cylinder	1
14	116343	SCREW, ground	1	40	203965	ROD, trip	1
15	156698	PACKING, o-ring	1	41	191125	CYLINDER, fluid	1
16*	112561	PACKING, block	1	42	183009	HOUSING, valve	1
17*	158367	GROMMET, lower valve	2	43	191122	PISTON, fluid	1
18*	160621	PACKING, o-ring	1	44	157182	RETAINER, ball	1
19	160624	PACKING, square	1	46**	234577	PLATE, muffler, serial number	1
20	167585	SPRING, compression, helical	2	47**	234578	PLATE, muffler, warning	1
21*	156633	PACKING, o-ring	1				
23	158360	YOKE, rod, trip	1				
24*	160261	NUT, valve	4				
25*	160618	WIRE, lock	2				
26	172866	CLIP, spring	2				
27	172867	ACUTATOR, valve	1				
28	238278	BASE, motor, air	1				
29	191124	ROD, displacement	1				
30	160932	GASKET, copper	1				

* Included in pump Repair Kit 238286

** Included in muffler Repair Kit 222559

***Use gap adjustment tool [171818](#) to ensure correct gap setting for poppets.

Part 237526, 425 (3:1) Pump Parts List

Ref. No.	Part No.	Description	Qty.	Ref. No.	Part No.	Description	Qty.
6	101178	BALL, piston; metallic	1	28	190229	BASE, air motor	1
8	108001	BALL, sst	1	29	190233	ROD, piston	1
9	101578	SCREW, cap, hex hd	8	31*	170709	POPPET, exhaust valve**	2
10	102975	SCREW, rd hd mach; 6-32 x 1/4"	2	32*	236079	VALVE, poppet	2
11†	112565	PACKING, u-cup	1	34	207391	PISTON	1
12†	166071	PACKING, o-ring	1	35	162629	CYLINDER, motor, air	1
13*	158379	PACKING, o-ring	1	36	158362	PIN, toggle	2
13S	189711	WASHER, piston	1	37	158364	PIN, pivot	2
14	116343	SCREW, grounding	1	38	160623	ARM, toggle	2
15	156698	PACKING, o-ring	1	39	190929	LIFT RING	1
16†	112130	SEAL, pump	1	40	207150	ROD, trip	1
17*	158367	GROMMET, inlet valve	2	41	189708	CYLINDER, pump	1
18*	158378	PACKING, o-ring	1	42	189709	VALVE HOUSING, 1 1/2 npt(f)	1
19	158377	PACKING, ring, seal	1	43	189707	PISTON/SEAT, valve	1
20	167585	SPRING, helical compression	2	44	189710	RETAINER, ball	1
21†	110828	PACKING, o-ring	1				
23	158360	YOKE, rod, trip	1				
23S	102656	MUFFLER, air exhaust	1				
24*	160261	NUT, valve	4				
25*	160618	WIRE, lock	2				
26	158361	CLIP, spring	2				
27	158359	ACTUATOR, valve, air	2				

* Included in air motor repair kit 207385

** Use gap adjustment tool [171818](#) to ensure correct gap setting for poppets.

† Included in lower repair kit 237602

Part 238108, 425 (6:1) Pump Parts List

Ref. No.	Part No.	Description	Qty.	Ref. No.	Part No.	Description	Qty.
6	101190	BALL, piston; metallic	1	27	158359	ACTUATOR, valve, air	2
8	101178	BALL, sst	1	28	190927	BASE, air motor	1
9	101578	SCREW, cap, hex hd	8	29	193799	ROD, piston	1
10	102975	SCREW, rd hd mach; 6-32 x 1/4"	2	31*	170709	POPPET, exhaust valve	2
11†	113347	PACKING, u-cup	1	32*	236079	VALVE, poppet**	2
12	166071	PACKING, o-ring	1	34	207391	PISTON	1
13*	158379	PACKING, o-ring	1	35	162629	CYLINDER, motor, air	1
13S	190924	WASHER, piston	1	36	158362	PIN, toggle	2
14	116343	SCREW, grounding	1	37	158364	PIN, pivot	2
15	156698	PACKING, o-ring	1	38	160623	ARM, toggle	2
16	112130	SEAL, pump	1	39	190929	LIFT RING	1
16S†	113346	SEAL, block, vee	1	40	207150	ROD, trip	1
17*	158367	GROMMET, inlet valve	2	41	190922	CYLINDER, pump	1
18*	158378	PACKING, o-ring	1	42	190926	VALVE HOUSING, 1 1/2 npt(f)	1
19	158377	PACKING, ring, seal	1	43	194016	PISTON/SEAT, valve	1
20	167585	SPRING, helical compression	2	44	190928	RETAINER, ball	1
21†	112349	PACKING, o-ring	1				
23	158360	YOKE, rod, trip	1				
23S	102656	MUFFLER, air exhaust	1				
24*	160261	NUT, valve	4				
25*	160618	WIRE, lock	2				
26	158361	CLIP, spring	2				

* Included in air motor repair kit 207385

** Use gap adjustment tool [171818](#) to ensure correct gap setting for poppets.

† Included in lower repair kit 238225

Part 205626, 425 (10:1) Pump Parts List

Ref. No.	Part No.	Description	Qty.	Ref. No.	Part No.	Description	Qty.
6	100279	BALL, piston; metallic	1	27	158359	ACTUATOR, valve, air	2
8	101190	BALL, sst	1	28	191544	BASE, air motor	1
9	101578	SCREW, cap, hex hd	8	29	191545	ROD, piston	1
10	102975	SCREW, rd hd mach; 6-32 x 1/4"	2	31*	170709	POPPET, exhaust valve	2
11	112564	PACKING, u-cup	1	32*	236079	VALVE, poppet**	2
12	166071	PACKING, o-ring	1	34	207391	PISTON	1
13*	158379	PACKING, o-ring	1	35	162629	CYLINDER, motor, air	1
13S	189711	WASHER, piston	1	36	158362	PIN, toggle	2
14	116343	SCREW, grounding	1	37	158364	PIN, pivot	2
15	156698	PACKING, o-ring	1	38	160623	ARM, toggle	2
16*	113564	SEAL, pump	1	39	190929	LIFT RING	1
16S	112565	SEAL, block, vee	1	40	207150	ROD, trip	1
17*	158367	GROMMET, inlet valve	2	41	191548	CYLINDER, pump	1
18*	158378	PACKING, o-ring	1	42	183009	VALVE HOUSING, 1 1/2 npt(f)	1
19	158377	PACKING, ring, seal	1	43	191547	PISTON/SEAT, valve	1
20	167585	SPRING, helical compression	2	44	157182	RETAINER, ball	1
21*	156633	PACKING, o-ring	1				
23	158360	YOKE, rod, trip	1				
23S	102656	MUFFLER, air exhaust	1				
24*	160261	NUT, valve	4				
25*	160618	WIRE, lock	2				
26	158361	CLIP, spring	2				

* Included in pump repair kit 238751

** Use gap adjustment tool [171818](#) to ensure correct gap setting for poppets.

225 (3:1) Technical Data (Data measured with 10 weight oil @70°F (21°C))

Fluid to air ratio3:1	Dry suction lift (feet of water).....23
Cycles/gallon (cycles/liter) 43.5 (11.4)	Wetted materials steel, polyurethane, aluminum, buna-N, Rulon®
Fluid flow @80 cpm (gpm/lpm) 1.84 (7.0)	Air inlet port size.....3/8 in. npt(f)
Pumping distance guideline..... up to 250 ft. (76.2 m)	Fluid inlet port size 1.5 in. npt(f)
Maximum fluid pressure..... 540 psi (3.7 MPa, 37 bar)	Fluid outlet port size 1/2 in. npt(f)
Air motor effective diameter 2.25 in. (57.2 mm)	Sound pressure (measured 1 meter from unit) .. 77.8dB
Air operating range 40-180 psi (0.28-1.2 MPa, 2.8-12 bar)	Sound pressure (ISO 9614-2) 85.6dB
Approx. air consumption and fluid flow @ 100 psi air and 80 cpm 8.5 scfm @ 2.1 gpm (.241 m ³ /min @ 7.9 lpm)	

225 (3:1) Performance Chart

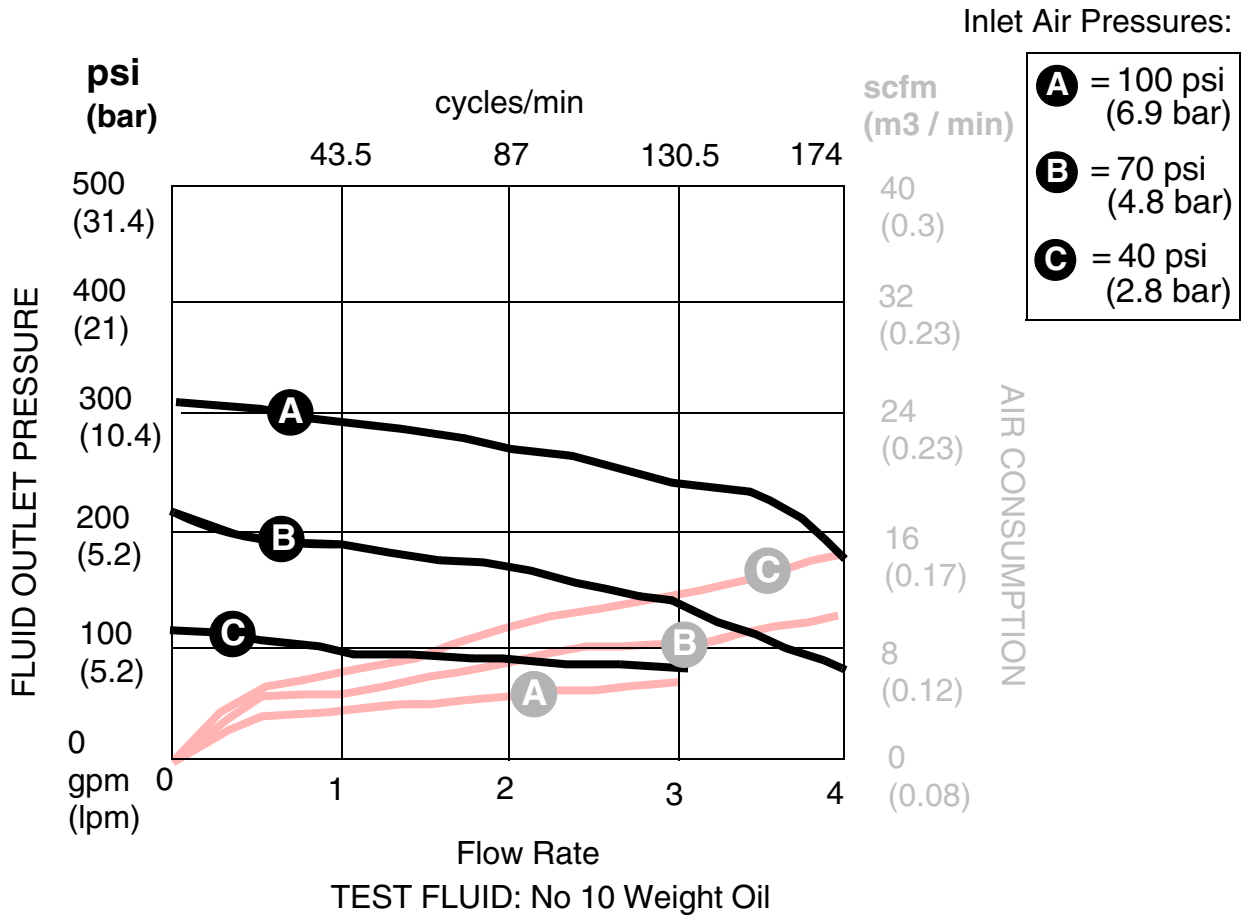

300 (5:1) Technical Data (Data measured with 10 weight oil @70°F (21°C))

Fluid to air ratio5:1	Dry suction lift (feet of water).....26
Cycles/gallon (cycles/liter)28.4 (8.6)	Wetted materials steel, polyurethane, aluminum, buna-N
Fluid flow @80 cpm (gpm/lpm)2.8 (9.3)	Air inlet port size.....3/8 in. npt(f)
Pumping distance guideline up to 500 ft. (152.5 m)	Fluid inlet port size1.5 in. npt(f)
Maximum fluid pressure.....900 psi (6.2 MPa, 62 bar)	Fluid outlet port size1/2 in. npt(f)
Air motor effective diameter3.0 in. (76.2 mm)	Sound pressure (measured 1 meter from unit) .. 77.8dB
Air operating range40-180 psi (0.28-1.2 MPa, 2.8-12 bar)	Sound pressure (ISO 9614-2) 85.6dB

Approx. air consumption and fluid flow @ 100 psi air and 80 cpm .27.0 scfm @3.0 gpm (.765 m³/min @ 11.5 lpm)

300 (5:1) Performance Chart

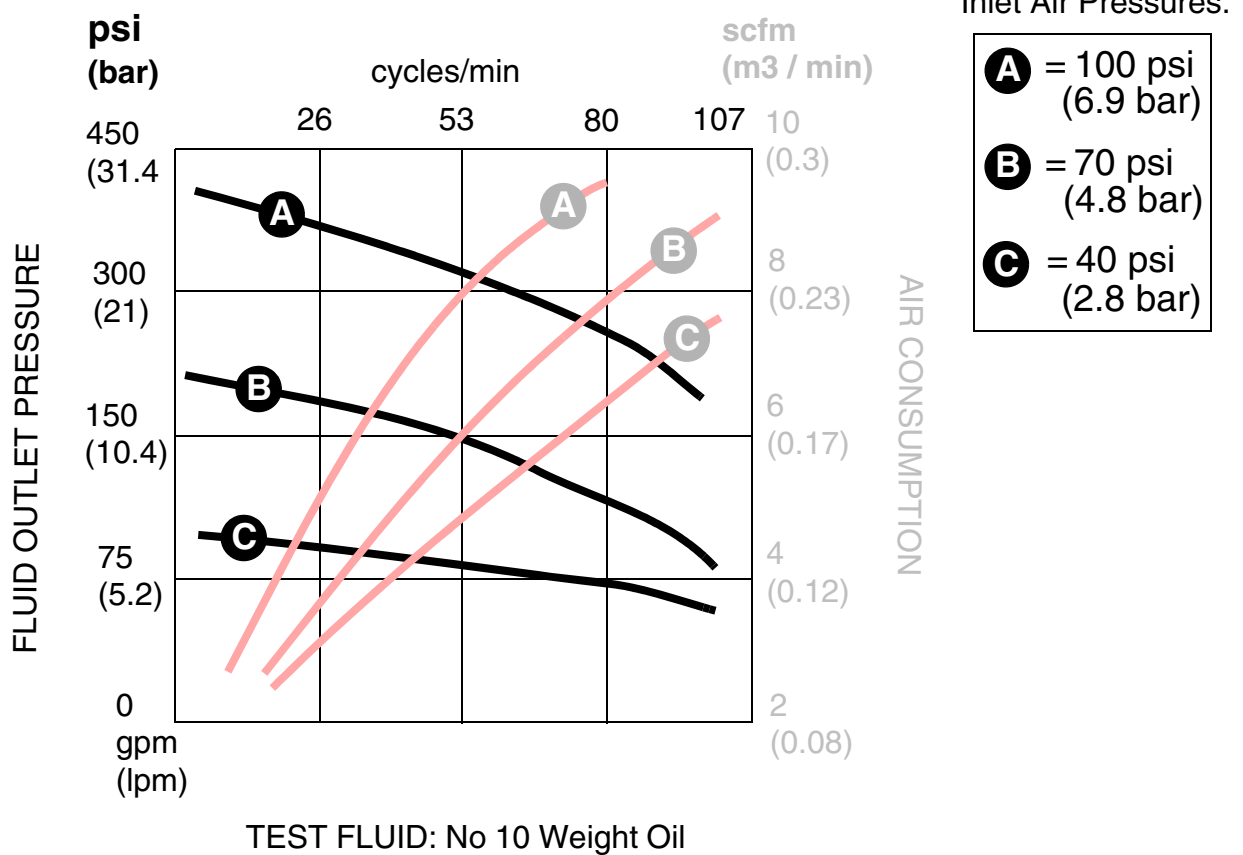

425 (3:1) Technical Data (Data measured with 10 weight oil @70°F (21°C))

Fluid to air ratio..... 3:1	Dry suction lift (feet of water) 26
Cycles/gallon (cycles/liter) 6.0 (1.6)	Wetted materials . steel, polyurethane, aluminum, nitrile
Fluid flow @80 cpm (gpm/lpm)..... 13.4 (50.6)	Air inlet port size 1/2 in. npt(f)
Pumping distance guideline..... up to 250 ft. (76.2 m)	Fluid inlet port size 1.5 in. npt(f)
Maximum fluid pressure 540 psi (3.7 MPa, 37 bar)	Fluid outlet port size 3/4 in. npt(f)
Air motor effective diameter 4.25 in. (107.9 mm)	Sound pressure (ISO 9614-2)..... 80.85dB
Air operating range 40-180 psi (0.28-1.2 MPa, 2.8-12 bar)	Sound pressure, tested in accordance with ISO 9614-2 94.62dB

Approx. air consumption and fluid flow @ 100 psi air and 80 cpm
58.0 scfm @ 13.4 gpm (.1.64 m³/min @ 50.6 lpm)

425 (3:1) Performance Chart

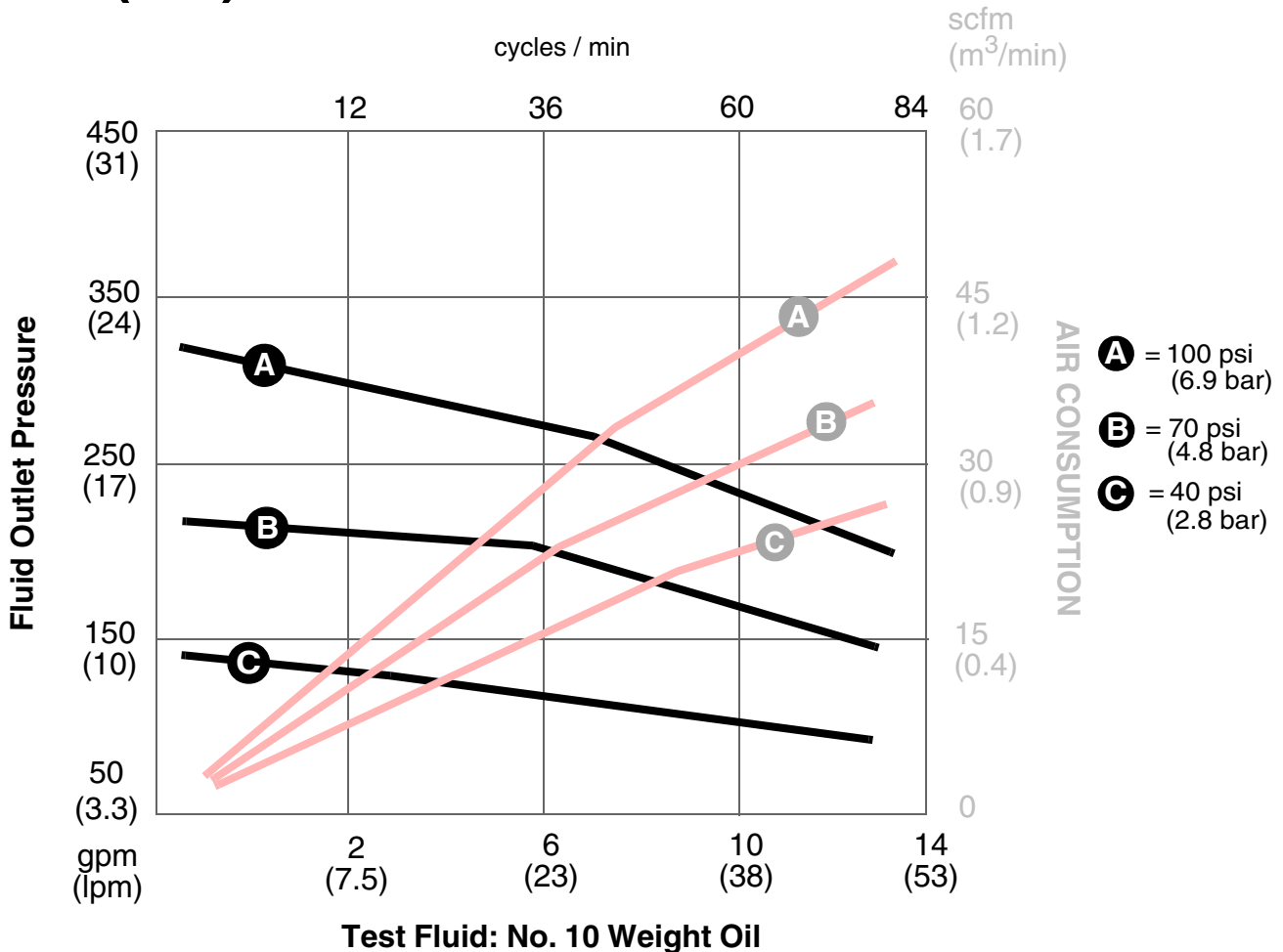

425 (6:1) Technical Data (Data measured with 10 weight oil @70°F (21°C))

Fluid to air ratio	6:1	Dry suction lift (feet of water).....	23
Cycles/gallon (cycles/liter)	12.0 (3.2)	Wetted materials .	steel, polyurethane, aluminum, nitrile
Fluid flow @80 cpm (gpm/lpm)	6.6 (25.3)	Air inlet port size.....	1/2 in. npt(f)
Pumping distance guideline	up to 500 ft. (152.5 m)	Fluid inlet port size	1.5 in. npt(f)
Maximum fluid pressure.....	1100 psi (7.6 MPa, 76 bar)	Fluid outlet port size	3/4 in. npt(f)
Air motor effective diameter	4.25 in. (107.9 mm)	Sound pressure (measured 1 meter from unit)	80.85dB
Air operating range	40-180 psi (0.28-1.2 MPa, 2.8-12 bar)	Sound pressure (ISO 9614-2)	94.62dB

Approx. air consumption and fluid flow @ 100 psi air and 80 cpm .49.5 scfm @6.8 gpm (.334 m³/min @25.7 lpm)

425 (6:1) Performance Chart

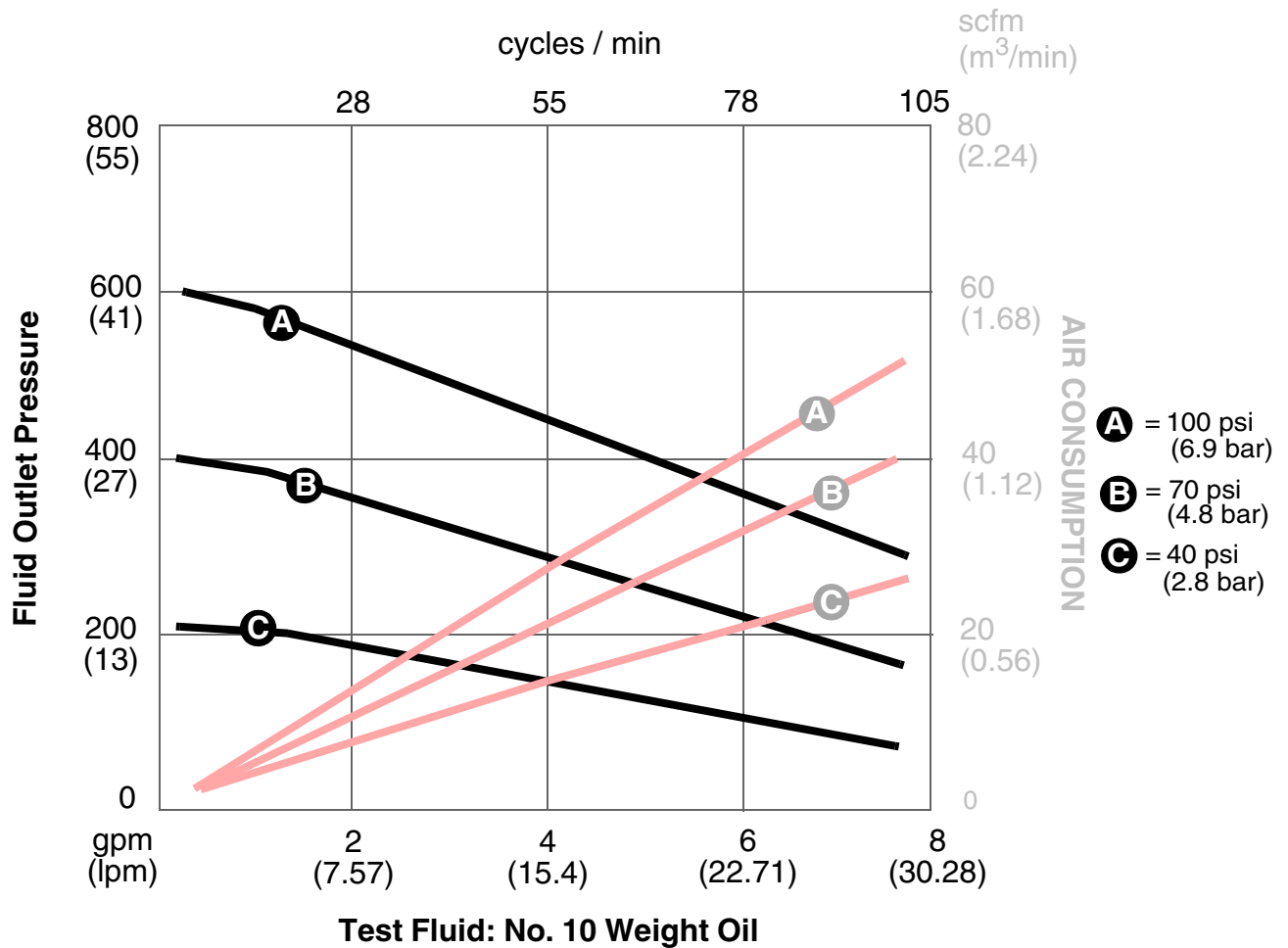

425 (10:1) Technical Data (Data measured with 10 weight oil @70°F (21°C))

Fluid to air ratio..... 10:1	Dry suction lift (feet of water) 26
Cycles/gallon (cycles/liter)..... 19.6 (5.2)	Wetted materials ..steel, polyurethane, aluminum, nitrile
Fluid flow @80 cpm (gpm/lpm)..... 4.1 (15.4)	Air inlet port size 1/2 in. npt(f)
Pumping distance guideline up to 750 ft. (228.6 m)	Fluid inlet port size..... 1.5 in. npt(f)
Maximum fluid pressure .. 1800 psi (12.4 MPa, 124 bar)	Fluid outlet port size..... 3/4 in. npt(f)
Air motor effective diameter.....4.25 in. (107.9 mm)	Sound pressure (measured 1 meter from unit) .80.85dB
Air operating range.... 40-180 psi (0.28-1.2 MPa, 2.8-12 bar)	Sound pressure (ISO 9614-2).....94.62dB

Approx. air consumption and fluid flow @100 psi air and 80 cpm. 32.0 scfm @4.1 gpm (.555 m³/min @15.4 lpm)

425 (10:1) Performance Chart

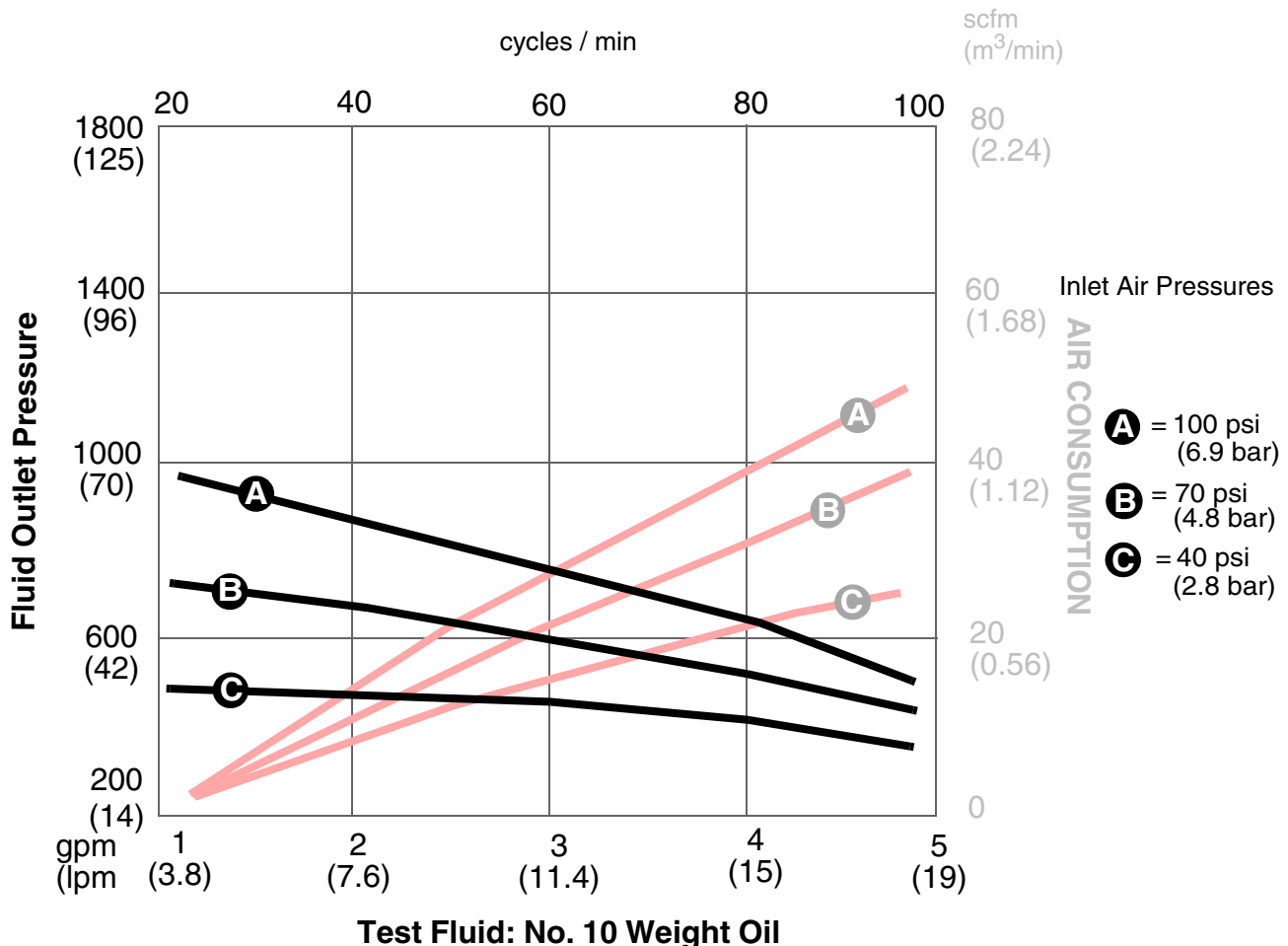

Notes

Graco Standard Warranty

Graco warrants all equipment referenced in this document which is manufactured by Graco and bearing its name to be free from defects in material and workmanship on the date of sale to the original purchaser for use. With the exception of any special, extended, or limited warranty published by Graco, Graco will, for a period of twelve months from the date of sale, repair or replace any part of the equipment determined by Graco to be defective. This warranty applies only when the equipment is installed, operated and maintained in accordance with Graco's written recommendations.

This warranty does not cover, and Graco shall not be liable for general wear and tear, or any malfunction, damage or wear caused by faulty installation, misapplication, abrasion, corrosion, inadequate or improper maintenance, negligence, accident, tampering, or substitution of non-Graco component parts. Nor shall Graco be liable for malfunction, damage or wear caused by the incompatibility of Graco equipment with structures, accessories, equipment or materials not supplied by Graco, or the improper design, manufacture, installation, operation or maintenance of structures, accessories, equipment or materials not supplied by Graco.

This warranty is conditioned upon the prepaid return of the equipment claimed to be defective to an authorized Graco distributor for verification of the claimed defect. If the claimed defect is verified, Graco will repair or replace free of charge any defective parts. The equipment will be returned to the original purchaser transportation prepaid. If inspection of the equipment does not disclose any defect in material or workmanship, repairs will be made at a reasonable charge, which charges may include the costs of parts, labor, and transportation.

THIS WARRANTY IS EXCLUSIVE, AND IS IN LIEU OF ANY OTHER WARRANTIES, EXPRESS OR IMPLIED, INCLUDING BUT NOT LIMITED TO WARRANTY OF MERCHANTABILITY OR WARRANTY OF FITNESS FOR A PARTICULAR PURPOSE.

Graco's sole obligation and buyer's sole remedy for any breach of warranty shall be as set forth above. The buyer agrees that no other remedy (including, but not limited to, incidental or consequential damages for lost profits, lost sales, injury to person or property, or any other incidental or consequential loss) shall be available. Any action for breach of warranty must be brought within two (2) years of the date of sale.

GRACO MAKES NO WARRANTY, AND DISCLAIMS ALL IMPLIED WARRANTIES OF MERCHANTABILITY AND FITNESS FOR A PARTICULAR PURPOSE, IN CONNECTION WITH ACCESSORIES, EQUIPMENT, MATERIALS OR COMPONENTS SOLD BUT NOT MANUFACTURED BY GRACO. These items sold, but not manufactured by Graco (such as electric motors, switches, hose, etc.), are subject to the warranty, if any, of their manufacturer. Graco will provide purchaser with reasonable assistance in making any claim for breach of these warranties.

In no event will Graco be liable for indirect, incidental, special or consequential damages resulting from Graco supplying equipment hereunder, or the furnishing, performance, or use of any products or other goods sold hereto, whether due to a breach of contract, breach of warranty, the negligence of Graco, or otherwise.

FOR GRACO CANADA CUSTOMERS

The Parties acknowledge that they have required that the present document, as well as all documents, notices and legal proceedings entered into, given or instituted pursuant hereto or relating directly or indirectly hereto, be drawn up in English. Les parties reconnaissent avoir convenu que la rédaction du présente document sera en Anglais, ainsi que tous documents, avis et procédures judiciaires exécutés, donnés ou intentés, à la suite de ou en rapport, directement ou indirectement, avec les procédures concernées.

Graco Information

TO PLACE AN ORDER, contact your Graco distributor, or call this number to identify the distributor closest to you:

1-800-533-9655 Toll Free

612-623-6928

612-378-3590 Fax

*All written and visual data contained in this document reflects the latest product information available at the time of publication.
Graco reserves the right to make changes at any time without notice.*

This manual contains English. MM 309869

Graco Headquarters: Minneapolis

International Offices: Belgium, Korea, China, Japan

GRACO INC. P.O. BOX 1441 MINNEAPOLIS, MN 55440-1441

www.graco.com

07/2004, Revised 09/2007